

PROMOTIONAL GADGETS

23.24



ARTICOLI PROMOZIONALI PERSONALIZZABILI



Articoli da scrittura

penne Italiane
penne estere
penne firmate
penne touch
penne in bamboo
penne in metallo
penne in plastica
matite
stilofori
pastelli
penne spray
astucci



Ufficio & Cartotecnica

planning
sottobraccio
carte da gioco
desk set
vaschette
righelli
portapenne
portadocumenti
blocchettame
post-it
cartelle
notes
tappetini mouse



Viaggi & Affari

borse legali
borse meeting
cartelle meeting
trolley
valigeria
set viaggio
zaini
portadocumenti



Free Time & Sport

travel
zaini
sacche
borselli
portacellulare
occhiali
teli palestra
teli mare
borsoni
borracce
thermos
palloncini



*Accessori Auto
& Lanyards*

portachivi
portacards
portadocumenti
cornici targhe
profumatori
parasole
nastri da collo
portabadge
porta smartphone



Lui & Lei

necessaire
foulards
appendiborse
trousse
specchietti
portacards
portamonete
portabiti
calzascarpe
cinture



*Farmacia &
protezione*

calendario del farmacista
termometri
portapillole
portaricette
borse
penne
portacards
mascherine
gel disinfettante
visiere



Hi - Tech

accessori
usb
multiprese
power bank
adattatori
pen drive
calcolatrici
base ricarica
porta smartphone



 **240**

Home & Living

- tovaglie
- menù
- wine set
- cavatappi
- tazze
- guanti e presine
- taglieri
- borse termiche
- borse portabottiglie
- ristorazione
- grembiuli

 **263**

Shopping

- borse boutique
- borse in carta
- borse in tnt
- borse in cotone
- borse portabottiglie
- take-away
- porta calici
- bavagli

 **300**

Time

- orologi da muro
- stazioni meteo

 **306**

Lighter

- accendini piezo
- accendini pietraina
- accendini con luce
- posaceneri tascabili
- posaceneri da spiaggia

 **314**

Metrica

- metri in legno
- rolline
- flessometri
- cutter
- matite falegname

 **319**

Rain

- impermeabili
- ombrelli

 **333**

Clothing

- t-shirt
- polo
- felpe
- caps
- scarpe
- guanti
- coperta

 **370**

workwear

- giubbotti
- smanicati
- pantaloni
- camicie
- tute
- camici
- grembiuli
- impermeabili
- alta visibilità
- cravatte

INDICE ALFABETICO

ACCENDINI : 308-309-310-311-312	DISCO ORARIO : 170
ADATTATORE PRESE UNIVERSALE: 232	DISPENCER PROFUMO: 186
ALIMENTATORE USB: 235	FAZZOLETTO : 364
ALTOPARLANTE BLUETOOTH: 778	FELPE: da 349 a 355
ANELLO PER CELLULARE: 236	FORBICI: 85-208
APPENDIBORSE : 184-206-207	GEL DISINFETTANTE : 219-222
APRIBOTTIGLIE : 250-251-252-253	GIACCA ANTPIOGGIA : da 329 a 332 da 411 a 413
ASTUCCI PER PENNE : 63	GIACCHE LAVORO: 394-396
BAVAGLIO RISTORANTE: 256-298	GILET EMERGENZA: 373
BERMUDA : 401	GREMBIULI: 257-258-259-260-275-297-408-409
BLOCCHI APPUNTI : 88-89	GUANTO FORNO : 257
BLOCK NOTES BAMBU' : 21-80	IMPERMEABILI: 329-330-331-332-411-412-413
BORRACCE : 124-126-127-128-129-130-131-132	LAMPADA BLUETOOTH : 238
BORSA PORTACOMPUTER : 98-100	LAMPADA PORTATILE : 329
BORSA PER SUBLIMAZIONE : 296	LANYARDS : 176-177-178-179-180
BORSA TROLLEY : 94	LEGGINS : 407
BORSE CARTA : 225-266-267-268-269	LIME: 208-
BORSE IN COTONE : 225-272-273-274	LINEA ECOLOGICA : 8-9
BORSE POLIESTERE : 295	MASCHERINE : 223
BORSE TERMICHE : 133-262	MATITE : 26-27-28
BORSE PORTADOCUMENTI : 93 e da 98 a 103	MATITE FALEGNAME : 315
BORSE TNT : 96-225 - da 276 a 294	METRI IN LEGNO: 315
BORSE TNT GLITTERATE : 280	MINI CAMION E MINI AUTOBUS : 188
BORSE TNT LAMINATO: 281-282-283	MULTIPRESA USB : 233
BORSONI SPORT : 122-123	NASTRI DA COLLO : 176-177-178-179-180
BRACCIALETTI : 137	NECESSAIRE: 190-191-192
BUSTE PORTADOCUMENTI : 84-166	NOTES CON ELASTICO : 78-79-80-81-82-83
CALCOLATRICI TASCABILI : 229	OCCHIALI VR REALTA' VIRTUALE: 236
CALCOLATRICI TAVOLO : 229	OCCHIALI DA SOLE : 135
CALENDARI PER FARMACIE: da 212 a 216	OMBRELLI GOLF : 320-325
CALZASCARPE : 209	OMBRELLI MANICO CURVO: 321-324-326-328
CAMICI E CAMICIE: 402-403-404	OMBRELLI MAXI GOLF : 322-323
CAPPELLINI : da 356 a 363 - 366-367	OMBRELLI PIEGHEVOLI : 326-327
CARTE DA GIOCO : 29-71	OROLOGI CON DATARIO : 301-303
CARTELLE CONGRESSO : 74-75-76-77-102-103	OROLOGI CON TERMOMETRO : 301-305
CAVATAPPI : 250-251-253	OROLOGI DA MURO : 301-302-303-305
CHIAVETTE USB : 230-231	OROLOGIO STAND : 304
CINTURE: 200	PALLONCINI : 136
CINTURE PER BAGAGLI : 97	PANTALONI: 388 e da 393 a 401 - 406
COFANETTI REGALO : 248-249	PARASOLE : 167
COPERTA : 369	PASTELLI : 27-28
CORNICI TARGA AUTO E MOTO: 167-169	PENNE BAMBU' : 22-23-24
CRAVATTE: 389	PENNA DIAMANTE : 44-204
CUBI CARTA : 68	PENNE ECOLOGICHE : 22-23-24-25
CUFFIE CON RETINA: 363-410	PENNE FARMACIA : 40-41-217-218-219
CUSTODIA REFRIGERANTE : 246	PENNE FIRMATE: 17
CUTTER : 85-318	PENNE INK GEL : 11-33
DESK PEN : 32-60-62	PENNE ITALIANE : 32
DESK SET : 66-67-68	PENNE LASER COLOR : 18

PENNE METALLO: da 12 a 19	POWER BANK : 235
PENNE PLASTICA : da 31 a 59	PRESINA : 257
PENNE PLASTICA-METALLO : da 31 a 59	PROFUMATORI AUTO : 186
PENNA PORTA SMARTPHONE : 38	RENDIRESTO : 243
PENNA ROSSETTO : 44-204	RIGHELLI CON PENNA E MATITA : 61
PENNE SIRINGA : 40	RIGHELLO LEGNO e PLASTICA : 29-70-71
PENNA SPRAY: 39-219	RISTORAZIONE : 242-243-244-245-246
PENNE TOUCH : 11-12-13-19-22-31-38-48-49-59	ROLLINE METRICHE : 316-317
PENNA TRICOLOR: 45	SCALDACOLLO : 365-367
PENNA TUBETTO : 40-218	SET APRIBOTTIGLIE : 250-251-252
PLANNING : 89-90	SET MANICURE : 205
POLO: 346-347-348-383-387	SET NOTES + PENNA : 79-80
PORTABADGE : 181-185	SET PASTELLI : 27-28
PORTABITI : 210	SET PENNE BAMBOO : 23
PORTABIGLIETTI VISITA : 201	SET PENNE METALLO : 11-14-15
PORTABOTTIGLIE : 248-249-255-299	SET PRESINA + GUANTO : 257
PORTACALICE : 256-298	SET UFFICIO SCUOLA : 61-70
PORTACAMICIE : 210	SET VINO : 247-248-249
P/CARTE CREDITO : da 172 a 175 da 194 a 199	SMANICATI : 371-372-375-376-381-386-391
P/CARTE c/PROTEZIONE RFDI : 175-194-195-198	SOTTOBRACCI : 72-86-87
PORTACELLULARE AUTO : 186-187-234-237	SOTTOBICCHIERI E SOTTOPIATTI: 244-245
PORTACHIAVI APPENDI BORSA : 184-206	SPAZZOLE : 205
PORTACHIAVI CARICATORE : 232	SPINA USB : 235
PORTACHIAVI - PORTA GETTONI : 185	SPECCHIETTI : 202
PORTACHIAVI CON STRASSE : 203	STAZIONE METEO : 301
PORTACHIAVI FICHES: 184	STILOFORI : 32-60-62
PORTACHIAVI FINTA PELLE : da 139 a 159	SVUOTATASCHE : 73
PORTACHIAVI IN FUSIONE : 152	TAGLIAPIZZE : 254
PORTACHIAVI IN LEGNO: 30-182	TAGLIERE : 261
PORTACHIAVI METALLO : 152-153-154-155	TAGLIAUNGHIE : 208
PORTACHIAVI PELLE : 142-143-144-145-148-149	TAPPETINO MOUSE PER SUBLIMAZIONE : 72-73
PORTACHIAVI PORTAMONETE : 183-192-201	TAKE AWAY: 264-265
PORTACHIAVI POSACENERE: 313	TAZZE : 241
PORTACHIAVI TESSUTO : 156-157	TELI PALESTRA E MARE : 119-120-121
PORTADOCUMENTI AUTO CUCITI : da 158 a 161	TERMOMETRI : 220
PORTADOC. ELETTRICALDATI : da 162 a 171	THERMOS : 125-126
PORTADOCUMENTI VIAGGIO : 97-165	TOVAGLIETTA : 246
PORTAFOGLI: 196-200	TRACOLLE : 112-113-115-270
PORTAMASCHERINE : 224	TROLLEY : 94-95
PORTAMENU : 242	T-SHIRTS : DA PAG. 334 A PAG. 345
PORTAMONETE : 183-192-193-201	TUTE DA LAVORO : 405
PORTAMONETE-PORTACARDS : 196	USB MEMORY : 230-231
PORTAPANE: 261	USB MULTIPRESA : 233
PORTAPILLOLE : 220-221	VALIGETTA : 93
PORTAPIZZE : 293	VISIERE : 227
PORTASCARPE : 210	ZAINI : 92 - da 105 a 118 - 122-123-271-296
PORTATESSERINO PROFESSIONALE : 199	WINE SET : 247-248-249-250
POSACENERE : 307-312-313	WINE LIST: 243
POST-IT : 65-66-67-69	WORKWEAR E TEMPO LIBERO: da 370 a 410

COD.	pag.	COD.	pag.	COD.	pag.	COD.	pag.	COD.	pag.
022	196	348	150, 159	455	25	561	169	654	208
024	200	349	151, 158	456	24	562	181	656	207
025	199	352	153	457	24	563	181	659	220
026	200	353	152	459	45	564	181	660	208
028	198	355	152	465	28	565	168	661	237
032	197	356	152	466	27	566	243	669	221
033	197	357	152	468	32	567	169	670	221
034	199	358	152	469	35	569	168	672	187, 234
035	201	360	30, 182	470	39, 219	570	242	673	187, 234
036	194, 195	361	30, 182	471	18	571	169	674	220
037	196	362	30, 182	472	48	572	245	676	239
038	198	374	143	473	16	573	245	677	167
039	193	375	142	474	44, 204	574	242	679	73
041	193	376	141	476	16, 63	575	73	680	72
130	80	377	139	479	19	576	244	682	135
135	78	378	140	480	49	578	167	683	135
136	82	380	149	481	59	580	244	685	87
138	81	381	148	485	62	581	136	686	86
156	83	383	144	489	23	582	243	687	236
161	89	396	151	490	22, 23	583	243	688	207
162	89	401	55	491	15	600	310	689	221
171	79	403	41, 217	494	17	601	311	690	205
172	81	407	42	496	14	602	310	691	29, 71
174	83	408	315	497	11	603	309	692	303
233	214	409	51	503	161	604	312	697	253
251	216	410	26	504	160	605	308	698	252
257	216	412	28	507	158	606	308	699	253
268	215	413	27	508	161	608	309	700	252
280	212, 213	414	45	509	159	610	307	701	86
300	146	415	31	514	166	610	307	702	85, 208
301	85, 318	417	40, 218	515	164	611	266	703	70
302	146	418	58	519	264	612	266	705	87
303	147	420	47	521	264	613	266	706	251
304	147, 160	421	54	522	224	614	266	707	251
305	145	422	43	522	224	615	266	708	250
306	184	423	36	523	175	616	225, 267	709	225, 289
309	154	424	53	524	174	617	225, 267	710	70
313	203	426	32	526	172, 226	618	225, 267	711	186
314	185	427	52	527	170	619	225, 267	712	29, 71
315	157	428	13	528	174, 226	621	225, 267	713	235
316	156	429	12	529	224	622	69	714	291
319	154, 203	430	46	530	163	623	21, 80	717	254
328	184, 206	431	24	531	173	624	265, 285	721	68
329	220, 213	432	11	532	162	625	265, 285	723	254
330	181	433	33	544	171	627	137	724	68
331	185	434	38	546	264	628	246	725	68
332	180	436	44, 204	547	136	630	61	728	312
333	180	440	50	548	136	631	61	729	261
335	178	442	37	550	264	632	27	731	69
336	177	443	34	551	168	633	186	732	129, 132
337	145	445	54	552	136	640	209	733	67
339	177	446	34	553	136	641	209	734	246
340	176	447	22	554	136	646	65	736	130
341	179	448	40, 218	555	171	647	202	737	313
343	155	450	60	556	175	648	66	738	234
344	155	451	59	557	170, 226	649	66	739	127
345	183, 201	452	57	558	173	651	318	740	129
346	192	453	56	560	181	652	205	741	131

COD.	pag.	COD.	pag.	COD.	pag.	COD.	pag.	COD.	pag.
742	125	861	98	935	295	1005	18, 63	1247	407
743	126	863	93	936	287	1019	88	1248	346
744	249	864	133, 262	937	296	1019/E	88	1249	403
745	248	865	133, 262	938	288	1020	88	1250	402
746	128	866	113	939	234	1020/E	88	1251	398
747	124	867	106, 107	940	294	1044	90	1252	391
748	126	868	111	942	365	1052	230	1253	391
751	124	869	122	943	364	1054	230	1255	346
752	241	870	123	944	293	1058	230	1256	351
754	249	871	105	945	372	1060	230	1257	405
755	192	872	92, 108	947	374	1061	231	1258	392
756	247	873	103	949	259, 409	1062	231	1259	393
758	233	875	183	950	257, 275	1064	231	1260	397
759	232	876	75	951	284	1068	231	1262	390
762	248	877	76	952	259, 409	1069	131	1263	390
763	301	878	100	953	286	1070	188	1264	393, 410
764	229	879	109	954	273	1071	188	1265	404
766	235	880	97, 165	955	329	1200	401	1266	404
767	229	881	210	956	331, 413	1201	395	1267	389
774	236	882	101	957	332, 412	1202	341	1268	389
775	232	884	210	958	256, 298	1203	341	1271	369
776	232	885	95	959	272	1204	341	1272	369
777	238	886	95	960	260, 408	1205	348	1273	406
778	238	888	277	961	276	1206	380	1274	406
783	302	889	96, 278	962	279	1207	344		
787	305	890	110	963	258	1208	344	B010	223
788	305	893	103	964	367	1209	378	B020	223
791	304	894	115, 270	966	295	1210	348	B121	222
802	315	897	93	967	260, 408	1211	379	B122	222
803	316	900	334, 335	968	280	1212	384	B123	219
804	317	901	334, 335	969	295	1213	345	B160	227
805	316	902	336, 337	970	323	1214	345	B162	227
811	317	903	336, 337	971	376	1215	349	B167	227
829	115, 271	907	340	972	279	1216	354		
831	117, 296	908	340	974	331, 413	1217	383		
832	116	910	347	975	373	1218	381		
835	225, 299	912	354	976	280	1219	375		
836	118	912	355	977	292	1220	400		
838	191	914	359	979	255, 299	1221	377		
839	112	915	356	980	121	1223	387		
840	190	916	371	981	282	1224	388		
841	134	917	362	982	281	1225	343		
842	268	918	361	983	283	1226	343		
843	269	919	358	984	119	1228	350		
844	269	920	357	985	120	1231	338, 339		
845	268	921	368	986	119	1232	338, 339		
846	102	922	373	988	255, 299	1234	347		
847	77	923	366	989	326	1235	386		
848	74	924	366	990	324	1236	385		
850	75	925	360	991	321	1237	352, 353		
851	94	926	362	992	320	1238	352, 353		
852	94	927	257	993	326	1239	396		
854	191	928	225, 274	994	322	1240	394		
855	114	929	363, 410	995	328	1241	342		
857	122	930	330, 411	996	325	1242	342		
858	84	932	261, 275	998	327	1244	399		
859	99	933	290	1002	22, 63	1245	382		
860	84, 166	934	256, 298	BOX 1003	132	1246	407		



Orologio bambù
Art. 763 - pag. 301



Post-it
Art. 648 - pag. 66
Art. 649 - pag. 66



Matita naturale
Art. 412 - pag. 28
Art. 413 - pag. 27



Post-it
Art. 646 - pag. 65



Penna paglia di grano
Art. 431 - pag. 24
Art. 455 - pag. 25



Blocchetto post-it
Art. 731 - pag. 69



Penna bambù
Art. 456 - pag. 24
Art. 457 - pag. 24



Blocco post-it
Art. 733 - pag. 67



Set pastelli
Art. 465 - pag. 28
Art. 466 - pag. 27



Blocchetto post-it
Art. 622 - pag. 69



Penna bambù
Art. 490 - pag. 22-23
Art. 447 - pag. 22



Notes con elastico
Art. 130 - pag. 80



Astuccio per penne
Art. 1002.22 - pag. 22-63



Notes con elastico
Art. 138 - pag. 81



Blocchetto bambù
Art. 623 - pag. 21-80



Portapane
Art. 932 - pag. 261-275



Grembiule
Art. 949 - pag. 259-297



Tracolla canvas
Art. 894 - pag. 115-270



Grembiule
Art. 950 - pag. 257-275



Borsa in heavy cotton
Art. 928 - pag. 225-274



Borse cotone colorato
Art. 954 - pag. 273



**Borse ecologiche
in kraft riciclato
manico ritorto**
Pag. 266-267



Borse cotone colorato
Art. 959 - pag. 272



Portachiavi in Legno
Art. 360 - pag. 30-182
Art. 361 - pag. 30-182
Art. 362 - pag. 30-182



Zaino in cotone
Art. 829 - pag. 115-271



Righello in Legno
Art. 712 - pag. 29-71



Borraccia in R Pet
Art. 746 - pag. 128



**Take away in carta
ecologica riciclata**
Pag. 264



Borracce in alluminio
Pagg. 127-129-130-131



**Carta da gioco
Ecologiche**
Art. 691 - pag. 29-71



**Borracce e thermos
in acciaio**
Pagg. 124-125-126

ARTICOLI DA SCRITTURA





432 PENNA "VICTORIA TOUCH" INK GEL

In alluminio rubber serigrafabile

Clip in metallo

Touch screen

Ink gel - refill nero

Misura Lunghezza mm 140

Materiale alluminio rivestito rubber

Stampa serigrafica/laser

QUADRICOMIA a richiesta

 area stampa mm. 35x7



02 nero

05 blu navy

08 grigio chiaro

497 SET "GIULIA TOUCH"

Penna sfera touch + penna ink gel touch

In alluminio rubber serigrafabile

In astuccio cartoncino con nastro in raso

Misura astuccio cm. 17,5x2,5

Stampa serigrafica

 area stampa cm. 5,5x1,5



02 nero



05 blu navy



08 grigio chiaro



429 PENNA "MARYLIN"

Antiscivolo
Clip in metallo
Soft Touch

Refill nero

Misura Lunghezza mm 140

Materiale alluminio e rubber

Stampa serigrafica

QUADRICOMIA a richiesta



area stampa mm. 35x7



01 bianco



02 nero



03 rosso



04 verde



05 blu navy



06 giallo

Effetto gomma serigrafabile



07 arancio



08 grigio chiaro



10 blu royal



14 azzurro



20 viola



21 verde mela



428 PENNA "SOPHIE"

Antiscivolo
Clip in metallo
Soft Touch

Refill nero

Misura Lunghezza mm 140

Materiale abs, rubber e metallo

Stampa serigrafica

QUADRICOMIA a richiesta

area stampa mm. 35x7



01 bianco

02 nero

03 rosso

04 verde

05 blu navy

06 giallo

Effetto gomma serigrafabile



07 arancio

08 grigio chiaro

10 blu royal

14 azzurro

20 viola

21 verde mela



496 PARURE "NANCY"

Sfera + Roller

In metallo e rubber serigrafabile

In astuccio cartoncino abbinato

Misura astuccio cm. 16x40x23

Materiale metallo rivestito rubber

Stampa serigrafica

QUADRICOMIA a richiesta



area stampa mm. 70x18

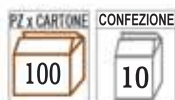

02 nero



03 rosso



05 blu navy



491 SET "LUXURY"

Penna a sfera + roller
 In metallo intarsiato e laccato
 In astuccio similpelle con cerniera
Misura astuccio mm 173 x 60 x 25
Misura penna mm 140
Materiale acciaio
Stampa serigrafica
 incisione Laser



area stampa mm. 70x18

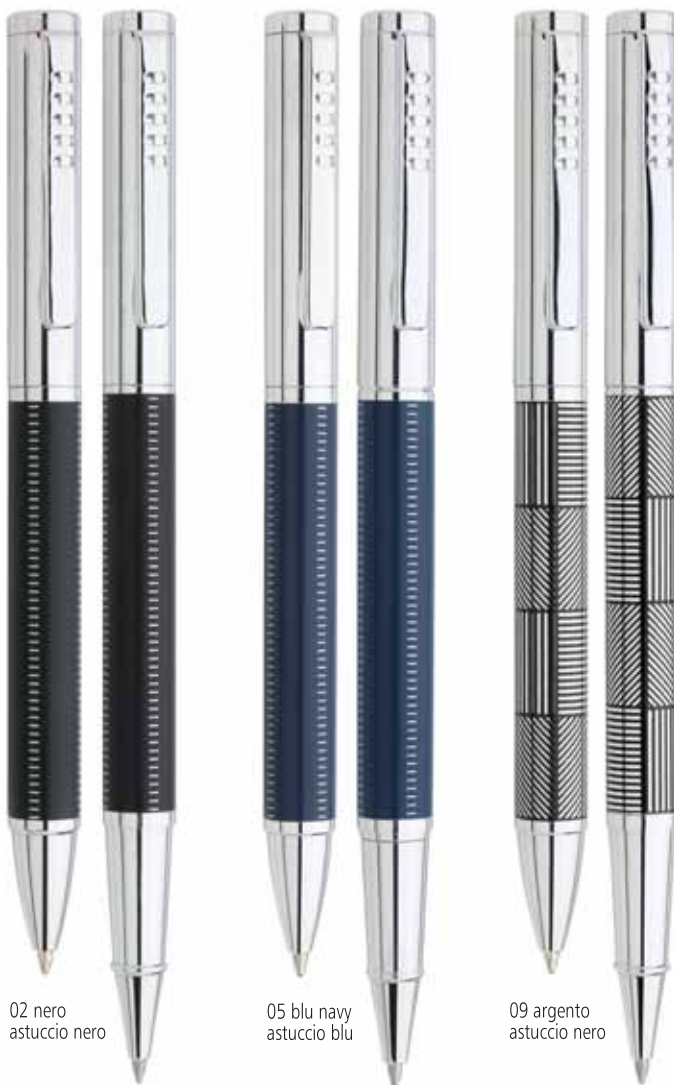

02 nero
astuccio nero

05 blu navy
astuccio blu

09 argento
astuccio nero

TRIPLO REFILL IN METALLO INCHIOSTRO NERO



INCISIONE LASER SU CAPPUCCIO





473 PENNA "DARDO"

In metallo laccato
 Triplo refill nero in metallo
 Astuccio escluso
Misura Lunghezza mm 140
Materiale abs e metallo
Stampa serigrafica / laser



area stampa mm. 35x7

QUADRICOMIA a richiesta



TRIPLO REFILL IN METALLO INCHIOSTRO NERO

02 nero

01 bianco

05 blu navy

METALLO LACCATO

476 ASTUCCIO

In cartoncino nero
 con nastro argento
Misura cm. 17x5x2,5
Stampa serigrafica



area stampa cm. 5x1,5

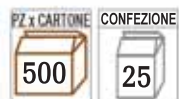



494 PENNA SFERA "PIERRE DELON"

In legno e metallo laccato
 Triplo refill nero in metallo
 In astuccio de lux finta pelle cucito con tasca
 Refil blu
Misura Lunghezza mm 140
Materiale legno e metallo laccato
Stampa laser

 area stampa mm. 35x7

PZ x CARTONE	CONFEZIONE
20	1





471 PENNA "MILLY" LASER COLOR

Incisione dello stesso colore della clip

Refill nero

Astuccio escluso

Misura Lunghezza mm 140

Materiale metallo

Stampa laser



area stampa mm. 30x7

PZ x CARTONE	CONFEZIONE
500	50



**Incisione
laser
a colori**



1005 ASTUCCIO PER PENNE

Misura mm 158x280x280

Materiale cartoncino nero

PZ x CARTONE	CONFEZIONE
500	50



479 METAL TOUCH

In metallo laccato
Touch Screen

Misura mm 140

Materiale metallo

Stampa serigrafica / laser

QUADRICOMIA a richiesta

area stampa mm. 30x7



Touch Screen



01 bianco

02 nero

03 rosso

04 verde

05 blu scuro

07 arancio

09 silver

49 canna di fucile

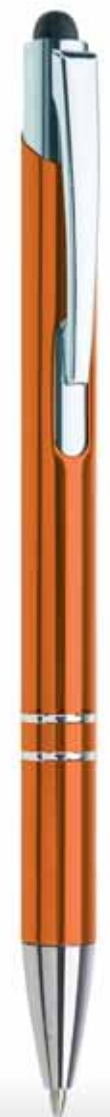



**HELP US TO SAVE
THE WORLD**





623 BLOCCO APPUNTI BAMBÙ

Blocco appunti spiralato + Penna sfera a scatto in bambù
Refill nero

In astuccio stampato bambù

Misura mm 90 x 140 x 11

Materiale carta e bambù

Stampa serigrafica



area stampa cm. 6x2



**Крoкпoкпoкoпiojioukjl
nkljiooi**





490 PENNA BAMBÙ

Penna a sfera a scatto "touch"

Refill nero

Misura Lunghezza mm 140

Materiale bambù e metallo

Stampa serigrafica / laser



area stampa mm. 30x7



**Refill
Jumbo**

1002 ASTUCCIO



49 metallo brunito

447 PENNA BAMBÙ GUN

Penna a sfera a scatto

Clip e particolari in metallo brunito

Refill nero

Astuccio compreso

Misura Lunghezza mm 140

Materiale bambù e metallo

Stampa serigrafica su astuccio



area stampa mm. 30x7



**Refill
Jumbo**

1002 ASTUCCIO



49 metallo brunito



489 SET BAMBÙ

Penna a sfera touch + portamine
Refill nero

Astuccio compreso

Misura Lunghezza mm 140

Materiale bambù e metallo

Stampa serigrafica su astuccio



area stampa mm. 80x25



1002 ASTUCCIO



09 silver

490 PENNA BAMBÙ

Penna a sfera a scatto "touch"
Refill nero

Misura Lunghezza mm 140

Materiale bambù e metallo

Stampa serigrafica / laser



area stampa mm. 30x7





456 PENNA BAMBÙ

Fusto in bambù
Particolari in plastica
Refill nero

Misura Lunghezza mm 140

Materiale bambù e plastica

Stampa serigrafica

QUADRICOMIA a richiesta



area stampa mm. 30x7



09 silver



457 PENNA BAMBÙ PAGLIA GRANO

Fusto in bambù
Particolari in paglia grano
Refill nero

Misura Lunghezza mm 140

Materiale bambù e paglia grano

Stampa serigrafica

QUADRICOMIA a richiesta



area stampa mm. 30x7



04 verde



06 giallo



14 azzurro



22 naturale



27 fuxia



22 naturale



14 azzurro



06 giallo



08 grigio



04 verde

431 PENNA "ECOLOGICA"

Penna ecologica

Refill nero

Misura Lunghezza mm 140

Materiale paglia di grano

Stampa serigrafica

QUADRICOMIA a richiesta



area stampa mm. 35x7





455 PENNA "NATURA"
CLIP LARGA

Penna ecologica
Clip per personalizzazione
Refill nero

Misura Lunghezza mm 140

Materiale paglia di grano

Stampa serigrafica

QUADRICOMIA a richiesta

 area stampa mm. 35x7

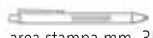
 area stampa mm. 35x7

PZ x CARTONE **CONFEZIONE**
 **1000**  **50**



06 giallo



08 grigio



14 azzurro



21 verde mela



22 naturale



27 fuxia





410 MATITE COLORATE CON GOMMINO

Misura Lunghezza mm 180

Materiale legno e metallo

Stampa serigrafica

QUADRICOMIA a richiesta

area stampa mm. 45x6



01 bianco

02 nero

03 rosso

04 verde

07 arancio

13 marrone

10 blu royal

14 azzurro



413

MATITE COLORATE FLOU CON GOMMINO NERO

Misura Lunghezza mm 180

Materiale legno e metallo

Stampa serigrafica

QUADRICOMIA a richiesta

area stampa mm. 45x6



05 blu navy



09 silver



10 blu royal



21 verde mela



27 fuxia



42 giallo limone

466

SET 6 PASTELLI

In cartoncino ecologico

Misura mm 40 x 95

Materiale legno

Stampa serigrafica

QUADRICOMIA a richiesta



area stampa mm. 35x45





412 MATITA CON GOMMINO

Misura Lunghezza mm 180

Materiale legno e metallo

Stampa serigrafica

area stampa mm. 45x6



465 SET 6 PASTELLI

In cartoncino ecologico

Cappuccio in plastica con temperamatite

Misura Diam. mm 27 x Alt. mm 100

Materiale plastica e legno

Stampa serigrafica

QUADRICOMIA a richiesta



area stampa mm. 45x20





712 RIGHELLO IN LEGNO

Spessore 28 mm.

Misura cm. 31x2,5

Materiale legno

Stampa serigrafica

QUADRICOMIA a richiesta



area stampa cm. 27x1,3

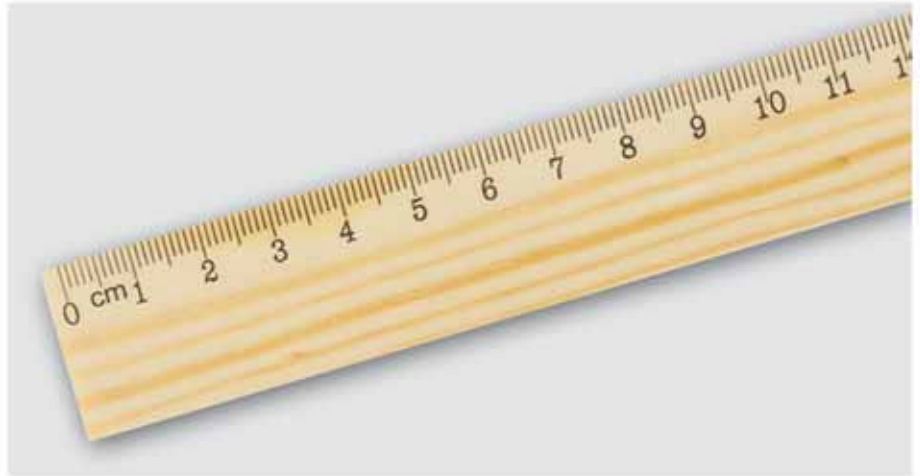

691 MAZZO CARTE DA GIOCO

54 carte

Ecologiche in carta riciclata

Misura cm. 5,8x9x1,8

Materiale carta riciclata

Stampa serigrafica



area stampa cm. 4x6,5





360 PORTACHIAVI IN LEGNO "SQUARE"

In bustina PVC

Misura diam. mm 40x7

Materiale legno e metallo

Stampa serigrafica / laser

QUADRICOMIA a richiesta



area stampa mm. 40x20



361 PORTACHIAVI IN LEGNO "RETTANGOLO"

In bustina PVC

Misura mm. 51x32x7

Materiale legno e metallo

Stampa serigrafica / laser

QUADRICOMIA a richiesta



area stampa mm. 40x20



362 PORTACHIAVI IN BAMBÙ PORTASMARTPHONE

Universale

Misura cm 6x2,5x1,5

Materiale bambù e metallo

Stampa serigrafica/laser

QUADRICOMIA a richiesta



area stampa mm. 22x16





APERTURA
MOVIMENTO
TWIST



415 PENNA "DIANA TOUCH"

Apertura movimento twist

Touch screen

Refill nero

Misura Lunghezza mm 140

Materiale abs - Anello in metallo

Stampa serigrafica

QUADRICOMIA a richiesta



area stampa m. 35x7



01 bianco

02 nero

03 rosso

04 verde

09 argento

10 blu royal





01 bianco



02 nero



03 rosso



05 blu navy

426 PENNA "LILIA EXTRA CHROME"

Clip in metallo

Misura Lunghezza mm 140

Materiale abs e metallo

Stampa serigrafica



area stampa mm. 30x6

PZ x CARTONE

2500

CONFEZIONE

100



468 DESK PEN

Orientabile

Catenina in metallo

Completo di biadesivo

Misura mm 50 x 80 x 200

Materiale plastica

Refill nero

Stampa serigrafica

QUADRICOMIA a richiesta



area stampa mm. 35x10

PZ x CARTONE
100

CONFEZIONE
10





433 PENNA "GLAMOUR INK GEL"

Clip in metallo

Colori effetto metallizzato

Impugnatura in gomma antiscivolo

Misura lunghezza mm 140

Materiale ABS e metallo

Refill nero o blu ink gel

Stampa serigrafica

QUADRICOMIA a richiesta

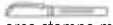

area stampa mm. 30x8

PZ x CARTONE

CONFEZIONE

1000

50

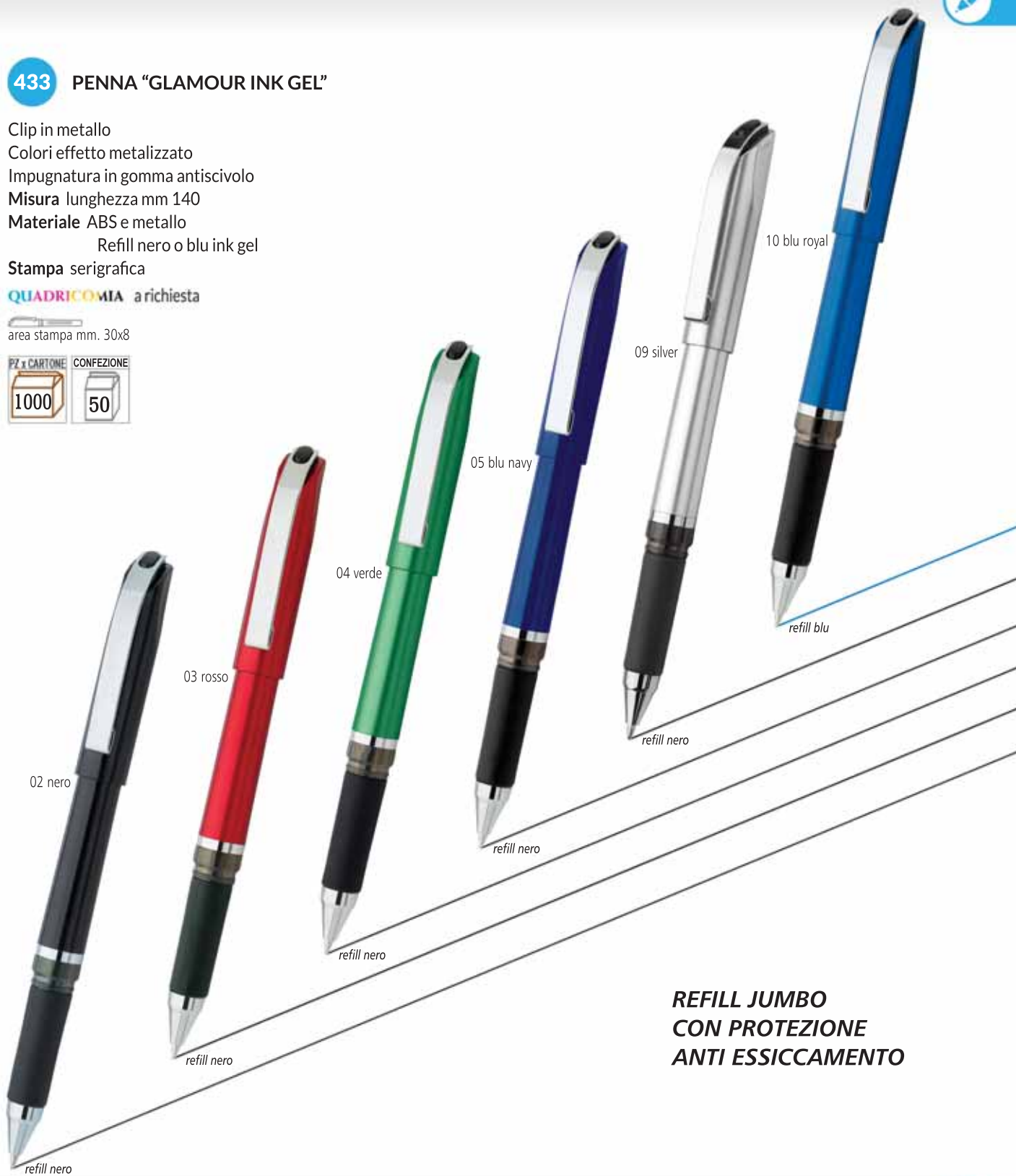

**REFILL JUMBO
CON PROTEZIONE
ANTI ESSICCAMENTO**



446 PENNA "RING FLAG"

Particolari colorati

Clip in metallo

Refill nero lunga durata

Misura Lunghezza mm 140

Materiale abs e metallo

Stampa serigrafica

QUADRICOMIA a richiesta



area stampa mm. 35x7



01 bianco

02 nero

05 blu navy



APERTURA
MOVIMENTO
TWIST

443 PENNA "RING COLOR"

Particolari silver

Clip in metallo

Refill nero lunga durata

Misura Lunghezza mm 140

Materiale abs e metallo

Stampa serigrafica

QUADRICOMIA a richiesta



area stampa mm. 35x7



APERTURA
MOVIMENTO
TWIST

02 nero

12 bordeaux

05 blu navy

09 silver

10 blu royal

21 verde mela





469 PENNA "I-STYLE"

Refill nero
Misura lunghezza mm 145
Materiale abs effetto soft
Stampa serigrafica

QUADRICOMIA a richiesta

area stampa cm. 3x0,8



**Finiture
nei colori
iPhone**



09 argento



11 oro



14 azzurro



19 rosa



47 rame

1005 ASTUCCIO PER PENNE

Misura mm 158x280x280
Materiale cartoncino nero





423 PENNA "TARGET METALLIC"

Colori metallizzati

Clip in metallo

Refill nero

Misura Lunghezza mm 140

Materiale abs

Stampa serigrafica

QUADRICOMIA a richiesta



area stampa mm. 35x7

**Nuovi
colori
iPhone**



49 canna di fucile



09 silver

11 oro



14 azzurro



47 rame



**Refill
Jumbo**



442 PENNA "ILENIA METALLIC"

Colori metallizzati
Clip in metallo
Refill nero
Misura Lunghezza mm 140
Materiale abs
Stampa serigrafica

QUADRICOMIA a richiesta

area stampa mm. 35x7



Nuovi colori iPhone



09 silver

11 oro

14 azzurro

47 rame

49 canna di fucile

Refill Jumbo





434 PENNA "SMART PHONE UNIVERSALE"

Base appoggio per smart phone universale

Colori metallizzati

Refill nero

Misura Lunghezza mm 140

Materiale plastica

Stampa serigrafica

QUADRICOMIA a richiesta



area stampa mm. 35x7



09 argento



05 blu navy



02 nero



470 PENNA SPRAY

Clip in metallo

Misura Lunghezza mm140

Materiale ABS e metallo

Refill nero

Stampa serigrafica

QUADRICOMIA a richiesta



area stampa mm. 30x8



01 bianco

04 verde

05 blu navy

06 giallo

07 arancio

10 blu royal



PROFUMAZIONE



ANTIAGGRESSIONE



ANTIZANZARE



IGIENIZZANTE

Per
Gel Igienizzante
vedi settore
Farmacia





448 PENNA "SIRINGA"

Misura Lunghezza mm 130

Materiale plastica

Refill nero

Stampa serigrafica

QUADRICOMIA a richiesta



area stampa mm. 35x10



01 bianco

03 rosso

04 verde

10 blu royal

417 PENNA "CREAM"

Con tappo chiusura

colore unico

Misura Lunghezza mm 118 - Diam. mm 26

Materiale plastica

Refill blu

Stampa serigrafica

QUADRICOMIA a richiesta



area stampa mm. 40x10



01 bianco





403 PENNA "FARMACIA" CON CADUCEO

Refill nero

Misura Lunghezza mm 140

Materiale abs

Stampa serigrafica

QUADRICOMIA a richiesta



area stampa mm. 30x8

PZ x CARTONE	CONFEZIONE
1000	50



04 verde



05 blu navy



05 blu navy

04 verde



407 PENNA BANNER

Fusto in ABS

Ampia clip per personalizzazione

Misura lunghezza cm 14

Materiale ABS

Refill nero

Stampa serigrafica

QUADRICOMIA a richiesta



area stampa mm. 15x30

area stampa mm. 32x7



10 blu royal

03 rosso

01 bianco

21 verde mela

05 blu navy

06 giallo





422 PENNA "PNEUMATICO"

Fusto effetto gomma

Refill nero

Misura Lunghezza mm 140

Materiale rubber e PVC

Stampa serigrafica

QUADRICOMIA a richiesta



area stampa mm. 30x7



area stampa mm. 30x7



03 rosso

06 giallo

09 argento

14 azzurro

21 verde mela



474 PENNA DIAMANTE

Fusto in plastica metallizzata

Pietra ornamentale

Movimento twist

Refill nero

Misura Lunghezza mm 140

Materiale plastica

Stampa serigrafica



area stampa mm. 35x7



09 argento

47 rame

48 multicolor



03 rosso



19 rosa

01 bianco



436 PENNA "ROSSETTO" CON LIQUIDO

Cappuccio colorato

Fusto ABS Trasparente con liquido

Refill nero

Misura Lunghezza mm 100 x diam. mm15

Materiale abs

Stampa serigrafica



area stampa mm. 25x15





414 PENNA "MONICA"

Apertura movimento twist

Refill nero lunga durata

Misura Lunghezza mm 145 x diam. mm 10

Materiale abs

Stampa serigrafica

QUADRICOMIA a richiesta

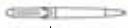

area stampa mm. 30x5

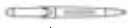

area stampa mm. 35x7



**DOPPIO LOGO
AL COSTO DI UNO**



02 nero

14 azzurro

27 fuxia



459 PENNA "TOUCH-COLOR"

Movimento twist 3 posizioni

Refill 3 colori: nero - blu - rosso

Misura Lunghezza mm 140

Materiale abs

Stampa serigrafica

QUADRICOMIA a richiesta



area stampa mm. 35x7

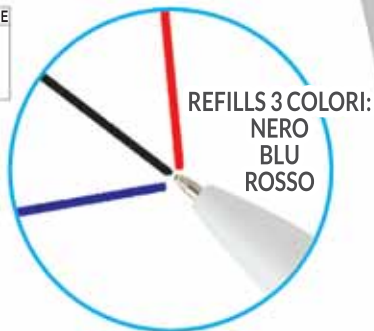

02 nero

03 rosso

05 blu navy



TOUCH
SCREEN

MOVIMENTO
TWIST PER SCELTA
REFIL



430 PENNA "VIRGINIA COLOR"

Refill nero

Misura Lunghezza mm 140

Materiale abs

Stampa serigrafica

QUADRICOMIA a richiesta



area stampa mm. 35x7





420 PENNA "TARGET"

Colori pastello
Clip in metallo
Refill nero

Misura Lunghezza mm 140

Materiale abs e metallo

Stampa serigrafica

QUADRICOMIA a richiesta



area stampa mm. 35x7



01 bianco

02 nero

03 rosso

04 verde

05 blu navy



06 giallo

07 arancio

10 blu royal

14 azzurro

20 viola

21 verde mela

27 fuxia



472 PENNA "ILENIA TOUCH METALLIK"

Impugnatura in gomma antiscivolo

Clip in metallo

Apertura movimento twist

Refill nero

Misura Lunghezza mm 140

Materiale abs in metallo

Stampa serigrafica

QUADRICOMIA a richiesta



area stampa m. 35x7





480 PENNA "ILENIA TOUCH WHITE"

Impugnatura in gomma antiscivolo

Clip in metallo

Apertura movimento twist

Refill nero

Misura Lunghezza mm 140

Materiale abs in metallo

Stampa serigrafica

QUADRICOMIA a richiesta



area stampa m. 35x7





440 PENNA "ILENIA COLOR"

Clip in metallo

Refill nero

Misura Lunghezza mm 140

Materiale abs e metallo

Stampa serigrafica

QUADRICOMIA a richiesta



area stampa mm. 35x7



02 nero

03 rosso

04 verde

05 blu navy

06 giallo

07 arancio

10 blu royal

14 azzurro

20 viola

21 verde mela

27 fuxia



409 PENNA "ILENIA"

Impugnatura in gomma fluo antiscivolo

Clip in metallo

Refill nero

Misura Lunghezza mm 140

Materiale abs e metallo

Stampa serigrafica

QUADRICOMIA a richiesta



area stampa mm. 35x7



01 bianco

02 nero

03 rosso

04 verde

05 blu navy

06 giallo

07 arancio

10 blu royal

14 azzurro

20 viola

21 verde mela

27 fuxia



427 PENNA "TETRIS COLOR"

Refill nero

Misura Lunghezza mm 140

Materiale abs

Stampa serigrafica

QUADRICOMIA a richiesta



area stampa cm. 3x0,8



02 nero



03 rosso

05 blu navy



10 blu royal



20 viola





424 PENNA "TETRIS WHITE"

Refill nero

Misura Lunghezza mm 140

Materiale abs

Stampa serigrafica

QUADRICOMIA a richiesta



area stampa mm. 32x7



02 nero



03 rosso



04 verde



06 giallo



07 arancio



10 blu royal



20 viola



05 blu navy





445 PENNA "GRETA"

Clip in acciaio

Apertura movimento twist

Refill nero

Misura Lunghezza mm 145

Materiale abs e metallo

Stampa serigrafica

QUADRICOMIA a richiesta



area stampa mm. 30x7



02 nero

APERTURA
MOVIMENTO
TWIST

03 rosso

04 verde

05 blu navy

421 PENNA "RANGE"

Clip in metallo

Refill nero

Misura Lunghezza mm 140

Materiale abs

Stampa serigrafica

QUADRICOMIA a richiesta



area stampa mm. 35x7



02 nero

07 arancio

10 blu royal



401 PENNA KATTY

Fusto colori perlati
 Particolari silver satinato
 Refill nero
 Misura Lunghezza mm 140
 Materiale abs
 Stampa serigrafica

QUADRICOMIA a richiesta

 area stampa mm. 35x7

PZ x CARTONE	CONFEZIONE
 1000	 50

01 bianco

02 nero

03 rosso

05 blu navy

06 giallo

07 arancio

09 argento

10 blu royal

21 verde mela





453 PENNA "MELISSA COLOR"

Refill nero

Misura Lunghezza mm 140

Materiale abs

Stampa serigrafica

QUADRICOMIA a richiesta



area stampa mm. 35x7

PZ x CARTONE

1000

CONFEZIONE

50



01 bianco



02 nero



03 rosso



04 verde



05 blu navy



06 giallo



07 arancio



09 silver



10 blu royal





452 PENNA "MELISSA WHITE"

Refill nero e blu
Misura Lunghezza mm 140
Materiale abs
Stampa serigrafica

QUADRICOMIA a richiesta

area stampa mm. 35x7

PZ x CARTONE	CONFEZIONE
1000	50



refill nero
02 nero

refill nero
03 rosso

refill nero
05 blu navy

refill nero
06 giallo

refill nero
07 arancio

refill nero
10 blu royal

refill blu
14 azzurro

refill nero
21 verde mela

refill nero
04 verde

MELISSA WHITE



**418 PENNA
"MELANIA GRIP"**

Impugnatura in gomma antiscivolo

Refill nero

Misura Lunghezza mm 140

Materiale abs

Stampa serigrafica

QUADRICOMIA a richiesta



area stampa mm. 35x7

PZ x CARTONE

CONFEZIONE

1000

50



06 giallo



07 arancio



bianco



08 grigio



02 nero



10 blu royal



03 rosso



14 azzurro



blu navy



21 verde mela





451 PENNA "MINI SFERA TOUCH"

Effetto metallizzato

Touch screen

Refill nero

Misura Lunghezza mm 107

Diam. mm 8

Materiale abs

Stampa serigrafica

QUADRICOMIA a richiesta

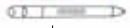

area stampa mm. 35x5

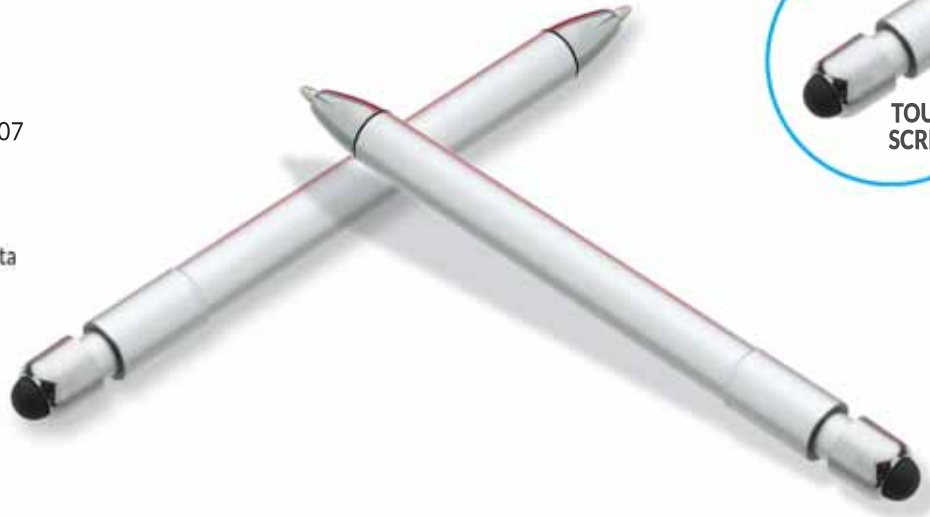

481 PENNA "MINI SFERA"

Colori effetto metallizzato

Refill nero

Misura Lunghezza mm 115

Diam. mm 8

Materiale abs

Stampa serigrafica

QUADRICOMIA a richiesta



area stampa mm. 35x5



01 bianco

03 rosso

05 blu navy

14 azzurro

21 verde mela



450 STILOFORO "CAR"

Spirale in plastica
 Completo di biadesivo
 Refill nero lunga durata
 Misura mm 50 x 130 x 75
 Materiale plastica
 Stampa serigrafica

QUADRICOMIA a richiesta



area stampa diam mm. 16



02 nero



03 rosso



10 blu royal





630 RIGHELLO 12 CM
CON PENNA TOUCH

Righello 12 cm in plastica flou
Penna silver touch
Refill nero
Misura mm 132 x 26
Materiale plastica
Stampa serigrafica

QUADRICOMIA a richiesta



area stampa mm. 60x6



631 RIGHELLO 12 CM
E MATITA CON GOMMINO

Righello 12 cm in plastica flou
Matita cm. 18 con gommino
Misura mm 132 x 26
Materiale plastica e legno
Stampa serigrafica

QUADRICOMIA a richiesta



area stampa mm. 60x6

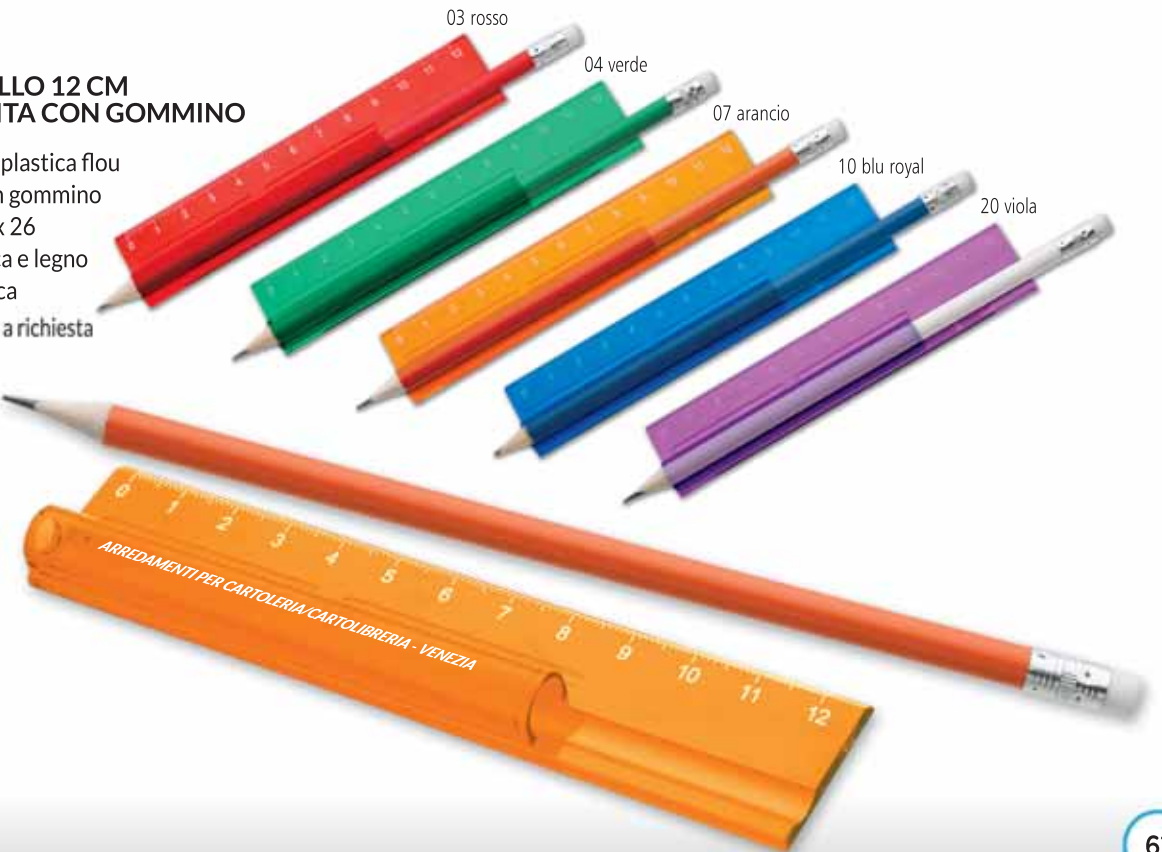



485 STILOFORO "SPINNER"

Stiloforo con Spinner

Penna a sfera

In astuccio cartoncino

Refill nero

Misura mm 75 x 75 x 160

Materiale abs in metallo

Stampa serigrafica

QUADRICOMIA a richiesta



area stampa mm. 35x8



**Astuccio
compreso**





1002 ASTUCCIO PER PENNE

Misura cm. 15,2x3,7

Materiale cartoncino effetto bambù



22 naturale

1005 ASTUCCIO PER PENNE

Misura cm. 15,8x2,8x2,8

Materiale cartoncino nero



02 nero

476 ASTUCCIO PER PENNE PER UNO O DUE POSTI

Misura cm. 17x5x2,5

Materiale In cartoncino nero con nastro argento



02 nero

UFFICIO E CARTOTECNICA

MADE IN ITALY

**SOTTOBRACCIO • CARTELLE CONGRESSO •
BLOCCHI APPUNTI • PLANNING • NOTES SPIRALATI •
VASCHETTE CARTA • POST-IT • CUBI CARTA • RIGHELLI**

IMPORT

**CARTELLE CONGRESSO • CUTTER • TIMBRI •
SVUOTATASCHE • FORBICI • CALCOLATRICI •
BUSTE PORTADOCUMENTI • RUBRICA • NOTES • POST-IT •
RIGHELLI • TAPPETINI MOUSE**



646 SET POST-IT ECOLOGICO + NOTES + PENNA

6 Post-it 3 formati

Notes in carta bianca

Penna in cartoncino ecologico

Misura cm. 14x10x1,5 (chiuso) - 21x14,5x1,5 (aperto)

Materiale cartoncino ecologico e carta

Stampa serigrafica

QUADRICOMIA a richiesta



area stampa cm. 7x4



10 blu royal

21 verde mela





649 SET ECOLOGICO POST-IT + RIGHELLO + PENNA

Post-it 2 formati con 7 colori

Penna in cartoncino ecologico

Righello 10 cm. in plastica

Misura cm. 16x6,3x2,3

Materiale cartoncino ecologico e carta

Stampa serigrafica

QUADRICOMIA a richiesta



area stampa cm. 12x4



22 naturale

648 POST-IT ECOLOGICO SPIRALATO

8 Post-it 2 formati

Misura cm. 7,5x7x2

Materiale cartoncino ecologico e carta

Stampa serigrafica



area stampa cm. 4,5x3,5



02 nero

22 naturale



733 DESK SET "CUBO"

Cubo carta 5 colori 500 fogli

Post-it streep 5 colori

Post-it gialli

Portapenne

Misura 8,5x8,5x8,5 (chiuso) - 17,5x8,5x8,5 (aperto)

Materiale cartoncino ecologico

Stampa serigrafica

QUADRICOMIA a richiesta



area stampa cm. 7x7



01 bianco



22 naturale



05 blu navy





725 BLOCCO CARTA

Cartoncino con portapenne

In astuccio

Misura cm. 11x10x3,5

Materiale carta bianca 1ª qualità gr.80

Stampa serigrafica

QUADRICOMIA a richiesta



area stampa cm. 7,2x1,2
area stampa cm. 8,8x3,4



02 nero



01 bianco

724 CUBO CARTA

Serigrafabile sui 4 lati

In astuccio

Misura cm. 8,5x8,5x8,5

Materiale carta bianca 1ª qualità gr.80

Stampa serigrafica

QUADRICOMIA a richiesta



area stampa cm. 8,5x8,5



721 CUBO CARTA

Serigrafabile sui 4 lati

In astuccio da pz. 2

Misura cm. 8,5x8,5x4,3

Materiale carta bianca 1ª qualità gr.80

Stampa serigrafica

QUADRICOMIA a richiesta



area stampa cm. 8,5x4,5





731 SET POST-IT 2 FORMATI

6 colori

Custodia rigida cartonata

Misura cm. 6x8,5x1,3 (chiuso)

Materiale carta e cartoncino

Stampa serigrafica

QUADRICOMIA a richiesta



area stampa cm. 6x5

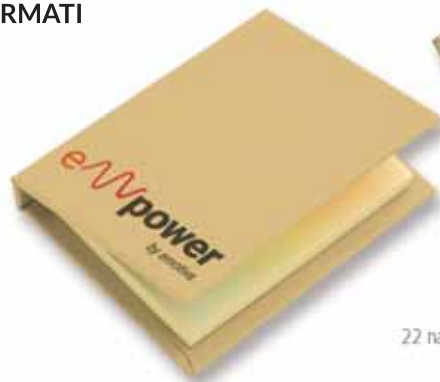

22 naturale

622 BLOCCHETTO POST-IT

100 fogli

Misura cm. 10,5x7x1

Materiale post-it giallo flou 1ª qualità gr.80

Stampa serigrafica

QUADRICOMIA a richiesta



area stampa cm. 10x6,5



01 bianco



710 SET UFFICIO - SCUOLA

Righello 30 cm. in plastica

2 matite con gommino

Gomma

Temperamatite

Misura cm. 31,5x4x1,6

Materiale pvc

Stampa serigrafica

QUADRICOMIA a richiesta



01 bianco



05 blu navy



area stampa cm. 4,5x1,5



06 giallo

703 RIGHELLO IN PVC

Spessore 2,2 mm.

Misura cm. 31,5x3,6

Materiale pvc rigido

Stampa serigrafica

QUADRICOMIA a richiesta



area stampa cm. 25x2

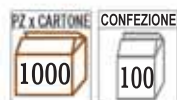

01 bianco

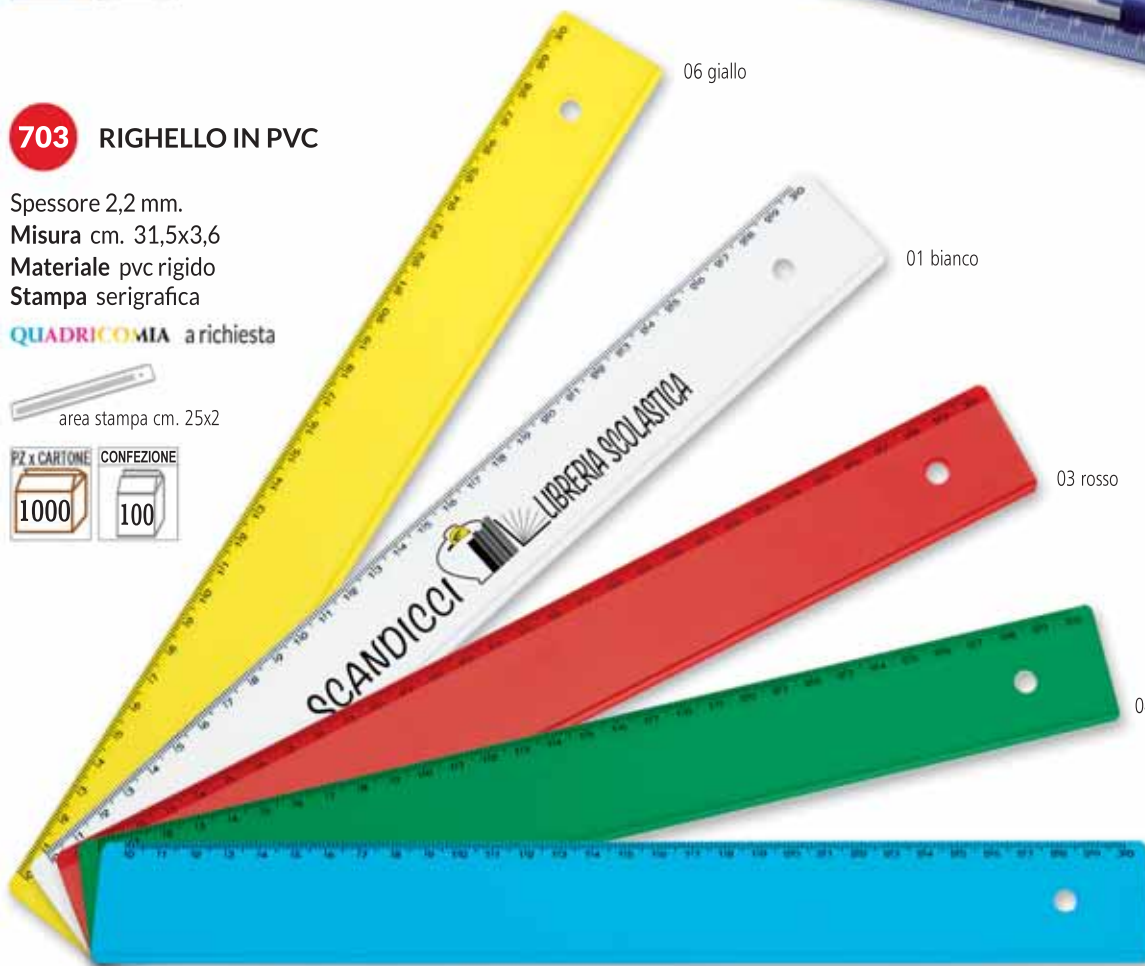

03 rosso

04 verde

14 azzurro



712 RIGHELLO IN LEGNO

Spessore 28 mm.

Misura cm. 31x2,5

Materiale legno

Stampa serigrafica

QUADRICOMIA a richiesta



area stampa cm. 27x1,3

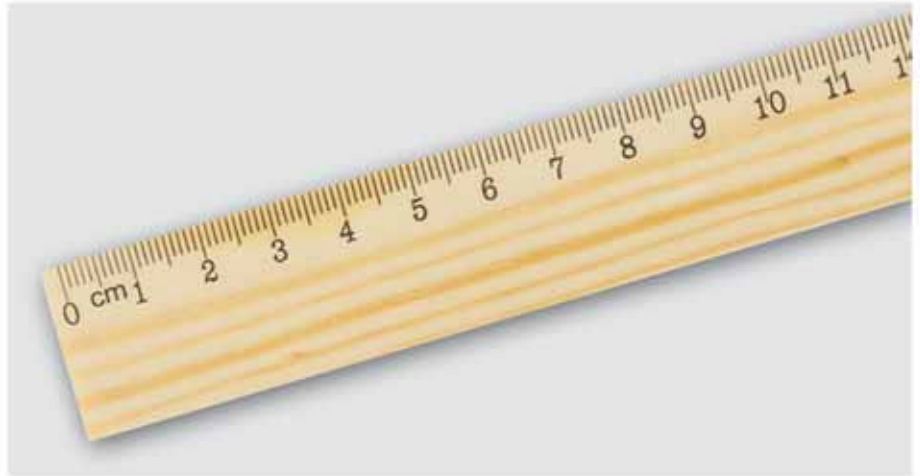

691 MAZZO CARTE DA GIOCO

54 carte

Ecologiche in carta riciclata

Misura cm. 5,8x9x1,8

Materiale carta riciclata

Stampa serigrafica



area stampa cm. 4x6,5





680

SOTTOBRACCIO - TAPPETINO MOUSE PER STAMPA SUBLIMATICA

Misura cm. 60x30

Materiale poliestere

Stampa sublimatica

QUADRICOMIA a richiesta



area stampa cm. 55x25



CORIM
SPARE PARTS FOR TRUCK AND TRAILER

duemila24
 Gennaio
 Febbraio
 Marzo
 Aprile
 Maggio
 Giugno

CORIM SRL
Via S. Salvatore 2, 80026 Casoria (NA)
Tel 081 7598467

CAMPANIA
S.S. Sannitica KM 26.500
81024 Maddaloni (CE)

ABRUZZO
Via Albegna 3
65128 Pescara (PE)

TOSCANA
Via Pratignone 82
50041 Calenzano (FI)

VENETO
Via delle Industrie 37
31047 Ponte di Piave (TV)

INFO@CORIM.NET
WWW.CORIM.NET
PIVA 05003451217
REA 726674

DENSO
MAGNETI
KINGBORNE
SAF
DLS



DEMOSION

CAMPANIA
S.S. Sannitica KM 26.500
81024 Maddaloni (CE)
Tel 081 7598467

CAMPANIA
Via Pratignone
81018 Poggioreale (SA)
Tel 081 1875037
Tel 081 1874886

CAMPANIA
Via Pratignone
81018 Gioia Teuro (BN)
Tel 0866 5218

ABRUZZO
Via del Frangiamore
70026 Mottola (BA)
Tel 080 836087
Tel 080 202061

ABRUZZO
Via Albegna
65128 Pescara (PE)
Tel 085 843636

ABRUZZO
Via Pratignone
50041 Calenzano (FI)
Tel 055 3195432

ABRUZZO
Via delle Industrie
31047 Ponte di Piave (TV)
Tel 0422 85462

ABRUZZO
Via Bottega
22033 Casaffranco Veneto (TV)
Tel 0423 72148

2024

GENNAIO
1 2 3 4 5 6 7 8 9 10 11 12 13 14 15 16 17 18 19 20 21 22 23 24 25 26 27 28 29 30 31

FEBBRAIO
1 2 3 4 5 6 7 8 9 10 11 12 13 14 15 16 17 18 19 20 21 22 23 24 25 26 27 28

MARZO
1 2 3 4 5 6 7 8 9 10 11 12 13 14 15 16 17 18 19 20 21 22 23 24 25 26 27 28 29 30 31

APRILE
1 2 3 4 5 6 7 8 9 10 11 12 13 14 15 16 17 18 19 20 21 22 23 24 25 26 27 28 29 30

MAGGIO
1 2 3 4 5 6 7 8 9 10 11 12 13 14 15 16 17 18 19 20 21 22 23 24 25 26 27 28 29 30 31

GIUGNO
1 2 3 4 5 6 7 8 9 10 11 12 13 14 15 16 17 18 19 20 21 22 23 24 25 26 27 28 29 30

LUGLIO
1 2 3 4 5 6 7 8 9 10 11 12 13 14 15 16 17 18 19 20 21 22 23 24 25 26 27 28 29 30 31

AGOSTO
1 2 3 4 5 6 7 8 9 10 11 12 13 14 15 16 17 18 19 20 21 22 23 24 25 26 27 28 29 30 31

SETTEMBRE
1 2 3 4 5 6 7 8 9 10 11 12 13 14 15 16 17 18 19 20 21 22 23 24 25 26 27 28 29 30

OTTOBRE
1 2 3 4 5 6 7 8 9 10 11 12 13 14 15 16 17 18 19 20 21 22 23 24 25 26 27 28 29 30 31

NOVEMBRE
1 2 3 4 5 6 7 8 9 10 11 12 13 14 15 16 17 18 19 20 21 22 23 24 25 26 27 28 29 30

DICEMBRE
1 2 3 4 5 6 7 8 9 10 11 12 13 14 15 16 17 18 19 20 21 22 23 24 25 26 27 28 29 30 31



679 TAPPETINO MOUSE PER STAMPA SUBLIMATICA

Misura cm. 22x18
 Materiale poliestere
 Stampa sublimatica
QUADRICOMIA a richiesta



area stampa cm. 20x15



01 bianco



575 SVUOTATASCHE CON BOTTONI

Apribile per stampa serigrafica
 Misura cm. 17x17 (aperto)
 Materiale pvc bicolore
 giallo/grigio
 blu navy/azzurro
 Stampa serigrafica
QUADRICOMIA a richiesta



area stampa cm. 11,5x2,5



09 silver

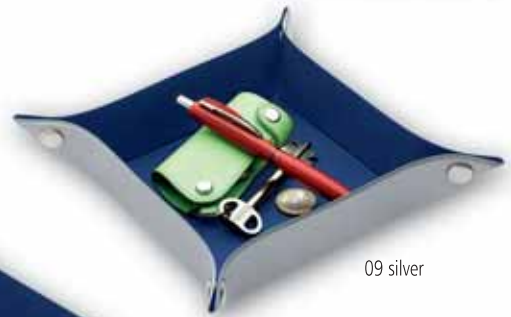

14 azzurro





848 CARTELLA CONGRESSO



Produzione italiana
 Portapenna (penna esclusa)
 Blocco in carta usomano 80 gr.
 Spiralato 40 fogli f.to A4 (incluso)
 In sacchetto TNT con lacci
Misura Lunghezza cm. 24x32
Materiale ecopelle termovirante
Stampa serigrafica

QUADRICOMIA a richiesta

Stampa a Fuoco pattina interna
 area stampa cm. 9x4,5



10 blu royal

02 nero

13 marrone

TERMOVIRANTE





876 CARTELLA MEETING

Clip con metallo
 Cartonata e imbottita
 Tasca interna in pvc
 Block notes escluso
Misura f.to A4 cm. 21x29,7
Materiale pvc elettrosaldato
Stampa serigrafica



area stampa cm. 13,5x5



10 blu royal

850 CARTELLA CONGRESSO

Portfolio con blocco compreso f.to A4
 Imbottita
 Tasca grande interna
 Pattina attrezzata multitasche
 Tasca portabiglietti visita
 Portapenne
 Chiusura calamitata
Misura Lunghezza cm. 25x32,5
Materiale coagulato termovirante
Stampa serigrafica



area stampa cm. 8x4



13 marrone



02 nero



877 CARTELLA CONGRESSO

Chiusura con cerniera
Tasche interne
con cerniera e a soffietto
Porta penna
Block notes A4 escluso
Misura chiusa m. 24,5x36,3
Materiale poliestere 600D
Stampa serigrafica

QUADRICOMIA a richiesta



area stampa cm. 9x4,5



21 verde mela

07 arancio





847 CARTELLA CONGRESSO

Chiusura con cerniera
Tasche interne
con cerniera e a soffietto
Porta penna
Block notes A4 escluso
Misura chiusa m. 24,5x36,3
Materiale poliestere 600D
Stampa serigrafica

QUADRICOMIA a richiesta



area stampa cm. 9x4,5



10 royal





135 NOTEBOOK CON ELASTICO IN COAGULATO

Pagg. 160

Carta stampata a righe

Angoli arrotondati

Portapenna (penna esclusa)

Misura mm. 140x210 c.a.

Materiale coagulato termovirante

Stampa serigrafica o stampa a fuoco



area stampa cm. 6x3



GRAFICA A RIGHE



02 nero



07 arancio



05 blu navy



TERMOVIRANTE



171 SET NOTEBOOK CON ELASTICO + PENNA IN ASTUCCIO

Grafica a righe

Notes f.to 15x21

Pagg. 160 - carta bianca

Con penna + portapenna

Astuccio coperchio + fondello

Misura mm. 230x190x17

Materiale coagulato termovirante

Stampa serigrafica su astuccio

QUADRICOMIA a richiesta



area stampa cm. 7x4

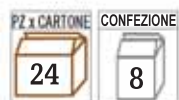

02 nero



05 blu navy



07 arancio

TERMOVIRANTE



130 NOTEBOOK ECOLOGICO CON ELASTICO

Pagg. 160

Angoli arrotondati

Portapenna (penna esclusa)

Misura mm. 90x140 c.a.

Materiale cartoncino naturale

Stampa serigrafica



area stampa cm. 5,5x3



21 verde mela



03 rosso



05 blu navy

623 BLOCCO APPUNTI BAMBÙ

Blocco appunti spiralato + Penna sfera a scatto in bambù

Refill nero

In astuccio stampato bambù

Misura mm 90 x 140 x 11

Materiale carta e bambù

Stampa serigrafica



area stampa cm. 6x2





138 NOTEBOOK ECOLOGICO CON ELASTICO

Pagg. 160

Angoli arrotondati

Portapenna (penna esclusa)

Misura mm. 140x210

Materiale cartoncino naturale

Stampa serigrafica

QUADRICOMIA a richiesta



area stampa cm. 6x3,5

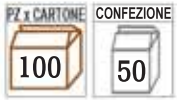

22 naturale

172 SET NOTEBOOK CON ELASTICO + PENNA IN ASTUCCIO

Notes f.to 15x21

Pagg. 160

Con penna + portapenna

Astuccio coperchio + fondello

Misura mm. 230x190x17

Materiale cartoncino naturale

Stampa serigrafica su astuccio

QUADRICOMIA a richiesta



area stampa cm. 7x4



22 naturale



136 NOTEBOOK CON ELASTICO "COLOR"
IN COAGULATO

Pagg. 160

Taglio colorato

Angoli arrotondati

Portapenna (penna esclusa)

Misura mm. 140x210 c.a.

Materiale coagulato termovirante

Stampa serigrafica o a fuoco

QUADRICOMIA a richiesta



area stampa cm. 5x3,5

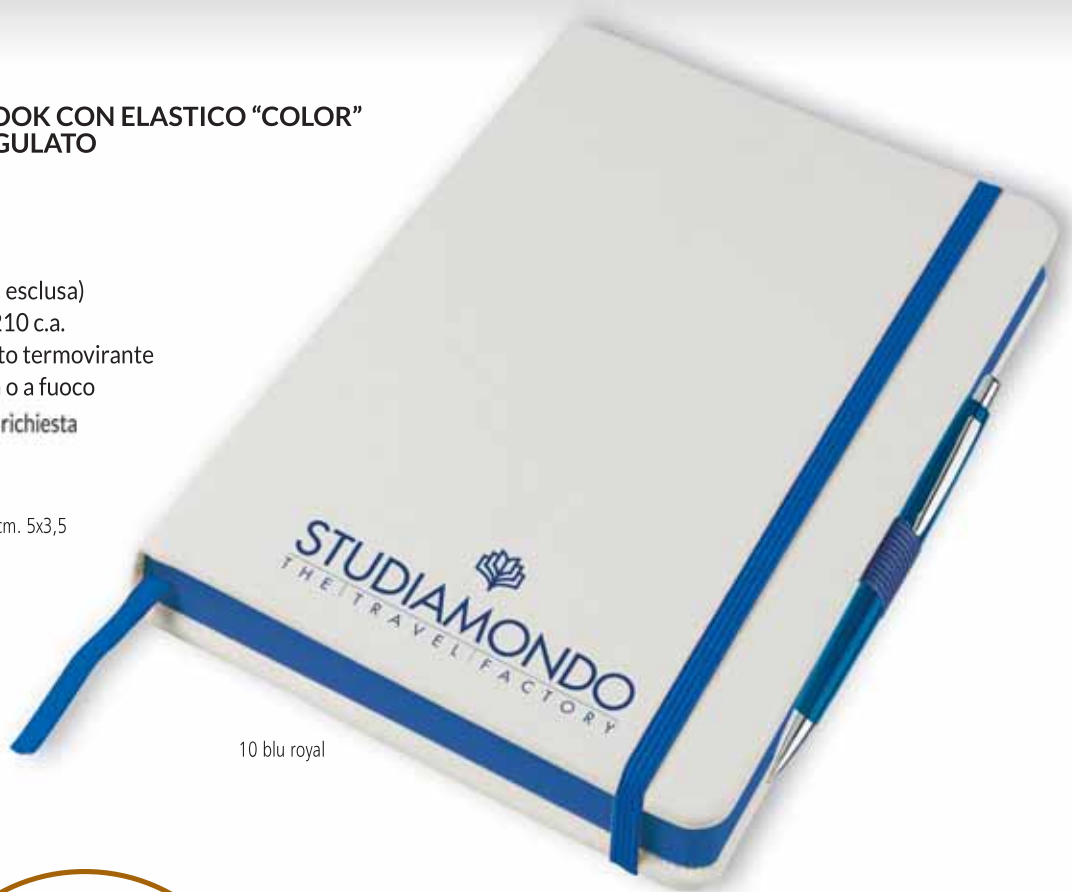

10 blu royal



**TAGLIO
COLORATO**





174 NOTES CON ELASTICO

GRAFICA A RIGHE

Pagg. 192

carta avorio stampata a righe

angoli arrotondati

Con portapenna e matita inclusa

astuccio in cartoncino bianco

misura cm. 7x10,5

materiale coagulato termovirante

stampa serigrafica o stampa a fuoco

QUADRICOMIA a richiesta



area stampa cm. 5x2



PZ x CARTONE

CONFEZIONE

200

50



05 blu navy



07 arancio



21 verde mela

156 RUBRICA IMBOTTITA "MATRA"

Pagg. 144 - carta bianca

24 tacche fustellate

Misura mm. 150x210

Materiale balakron tecnico

Stampa serigrafica

QUADRICOMIA a richiesta



area stampa mm. 65x35



PZ x CARTONE

CONFEZIONE

60

30



04 verde



860 BUSTA PORTADOCUMENTI

Chiusura con bottone
Misura cm. 24 x 17,5
Materiale pvc trasparente
Stampa serigrafica

QUADRICOMIA a richiesta



area stampa cm. 16x5



area stampa cm. 8x4



06 giallo trasparente



10 blu royal trasparente



18 trasparente

858 BUSTA PORTADOCUMENTI

Chiusura con bottone
Misura cm. 33,5 x 23,5
Materiale pvc trasparente
Stampa serigrafica

QUADRICOMIA a richiesta



area stampa cm. 20x8



area stampa cm. 8x4



04 verde trasparente



10 blu royal trasparente



01 bianco trasparente



06 giallo trasparente

03 rosso trasparente





301 MINI CUTTER CON LAMA PROGRESSIVA

Fermo di sicurezza
Catenina portachiavi
Misura mm 75x20x0,7
Materiale PVC + cristal
Stampa serigrafica

QUADRICOMIA a richiesta



area stampa cm. 5x0,8



01 bianco



02 nero



04 verde

702 FORBICE CON CUSTODIA

Molla di ritorno
Misura cm. 12x1,5x1
Materiale acciaio e abs
Stampa serigrafica

QUADRICOMIA a richiesta



area stampa cm. 5x0,4



04 verde



07 arancio



01 bianco



701 SOTTOBRACCIO
2 ANTE

Tasca portacarte interna

Misura cm. 51x37

Materiale cuoio

rigenerato termovirante

Stampa a fuoco

**Stampa
a Fuoco**



area stampa cm. 10x3

PZ x CARTONE



13 marrone



02 nero



03 rosso



05 blu navy



15 cuoio



13 marrone



17 testa di moro



26 salmone



43 verde acido

686 SOTTOBRACCIO
2 ANTE

Tasca portacarte interna

Misura cm. 39x27

Materiale cuoio rigenerato

termovirante

Stampa a fuoco

**Stampa
a Fuoco**



area stampa cm. 10x3

PZ x CARTONE



26 salmone



705 SOTTOBRACCIO

Rimboccato a mano

Misura cm. 51x32

Materiale cuoio
rigenerato
termovirante

Stampa a fuoco

**Stampa
a Fuoco**



area stampa cm. 10x3



17 testa di moro



02 nero



03 rosso



05 blu navy



15 cuoio



13 marrone



17 testa di moro



26 salmone



43 verde acido

685 SOTTOBRACCIO

Misura cm. 39,5x26

Materiale cuoio rigenerato
termovirante

Stampa a fuoco

**Stampa
a Fuoco**



area stampa cm. 10x3



26 salmone



1019 BLOCCO APPUNTI

Misura A5 cm. 15x21 - 80 fogli personalizzati
Materiale carta uso mano gr. 80
Stampa litografica



1019/E BLOCCO APPUNTI

Misura A5 cm. 15x21 - 40 fogli personalizzati
Materiale carta uso mano gr. 80
Stampa litografica



1020 BLOCCO APPUNTI

Misura A4 cm. 21x29,7 - 80 fogli personalizzati
Materiale carta uso mano gr. 80
Stampa litografica

1020/E BLOCCO APPUNTI

Misura A4 cm. 21x29,7 - 40 fogli personalizzati
Materiale carta uso mano gr. 80
Stampa litografica





161 PLANNING TAVOLO

50 fogli
 Cartonato e spillato in testa
Misura cm. 43x31
Materiale carta cartoncino
Stampa serigrafica
 area stampa base cm. 35x2,8



162 BLOCCO APPUNTI

Grafica puntinata
 50 fogli
 Cartonato e spillato in testa
Misura A4 cm. 21x29,7
Materiale carta e cartoncino
Stampa serigrafica
 area stampa base cm. 19x3

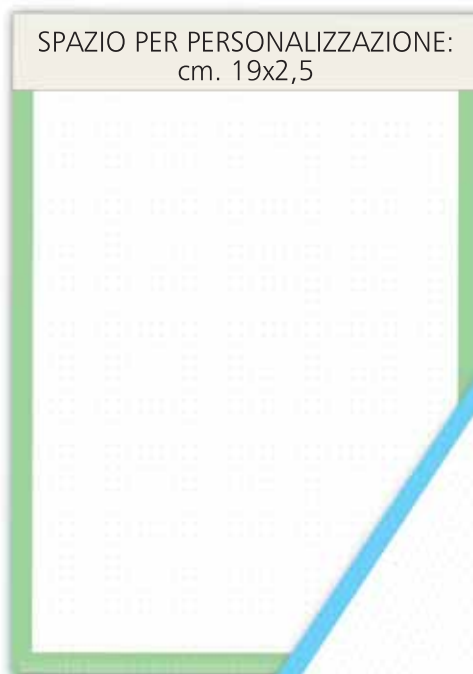

21 verde mela



14 azzurro

VIAGGI & AFFARI





872 ZAINO PORTACOMPUTER 15"



4 tasche con cerniera
 Divisioni e spallacci imbottiti
 Tasca portacomputer con chiusura
Misura cm. 33x46x16
Materiale tecnico 900 D
Stampa serigrafica



area stampa cm. 16x10

Stampa laser su targhetta metallica



area stampa cm. 4,5x0,8

PZ x CARTONE



PZ x BUSTA



**SCHIENALE
IMBOTTITO**



02 nero



08 grigio



897 VALIGETTA PORTACOMPUTER

Imbottita
 Doppio scomparto con cerniere
 3 tasche con cerniere
 Passante per trolley
 Tracolla con moschettoni in metallo
 In astuccio
 Misura cm. 40x30x12
 Materiale tecnico ed ecopelle
 Stampa serigrafica



cursori firmati



863 BORSA PORTADOCUMENTI

Manici in alluminio
 Tasca interna attrezzata
 Tracolla regolabile
 Misura mm 40x30,5x6,8
 Materiale microfibra
 Stampa incisione laser o serigrafica



TASCA INTERNA ATTREZZATA



Laser
area stampa cm. 2,6x1,2



serigrafica
area stampa cm. 20x8



852 BORSA TROLLEY 4 RUOTE

Misura mis. 19" cm. 46x41x21



851 BORSA TROLLEY 2 RUOTE

Misura mis. 15" cm. 38x35x19



AM
Andrea Milani
Time to work



MANICO TELESCOPICO

VANO PORTABITI

TASCA PORTACOMPUTER
IMBOTTITA

PATTINA ATTREZZATA
CON 3 TASCHE INTERNE
E PORTAPENNE

TASCA ESTERNA CON CERNIERA

DOPPIO FONDO CON CERNIERA

CURSORI FIRMATI

MATERIALE POLIESTERE 600D

BAGAGLIO A MANO



885 TROLLEY MEDIO

Misura cm. 40x60x24
area stampa cm. 4x1



886 TROLLEY GRANDE

Misura cm. 46x70x28
area stampa cm. 4x1



DOPPIO SCOMPARTO RIVESTIMENTO
INTERNO FODERATO E IMBOTTITO

AM
Andrea Milani
Time to work

TROLLEY RIGIDO
MATERIALE: ABS ANTIURTO
LEGGERO E RESISTENTE
4 RUOTE
MANICO TELESCOPICO IN ALLUMINIO



CHIUSURA CON COMBINAZIONE
BLOCCA CURSORI



area stampa cm. 4x1



889 BORSA PILOTA

Chiusura con cerniera

Tasca esterna con chiusura a velcro

Fondello rinforzato

Misura cm. 40 x 36 x 20

Materiale tnt cucito gr. 90

Stampa serigrafica



area stampa cm. 23x10

NO WOVEN	GRAMMI	PZ x CARTONE	PZ x BUSTA
	90	100	20



02 nero



05 blu navy



10 blu royal





880 PORTADOCUMENTI VIAGGIO

Chiusura con cerniera
 Misura cm. 32x23
 Materiale poliestere 600 D
 Stampa serigrafica

QUADRICOMIA a richiesta



area stampa cm. 20x10



area stampa cm. 8x5



10 blu royal

04 verde

632 CINTURA DI SICUREZZA PER BAGAGLI

Regolabile
 Misura cm. 180x5
 Materiale poliestere 600 D
 Stampa serigrafica

QUADRICOMIA a richiesta



area stampa cm. 20x3,5



01 bianco



02 nero



06 giallo



03 rosso



10 blu royal





861 BORSA PORTACOMPUTER



Scomparto imbottito interno
 Scomparto centrale chiusura con cerniera
 Doppia tasca frontale chiusura con cerniera e con velcro
 Tracolla regolabile
 Misura cm. 39x30x8
 Materiale poliestere 600 D
 Stampa serigrafica



area stampa cm. 10x4,5



03 rosso



21 verde mela



05 blu navy





859 BORSA PORTADOCUMENTI

Scomparto centrale chiusura con cerniera

Doppia tasca frontale chiusura con cerniera e con velcro

Doppio manico

Agganci per tracolla

Misura cm. 36x26x2,5

Materiale poliestere 600 D

Stampa serigrafica



area stampa cm. 11x5



02 nero



03 rosso



05 blu navy



21 verde mela





878 CARTELLA MEETING - PORTACOMPUTER 15"



Imbottita
 2 tasche con cerniera
 Fascia per aggancio trolley
 Misura cm. 39x27
 Materiale poliestere 600 D
 Stampa serigrafica



area stampa cm. 20x10



02 nero



08 grigio



10 blu royal



Imbottita



Fascia per aggancio trolley





882 BORSA CONFERENCE

Tasca con cerniera attrezzata
 Scomparto con cerniera
 Portacellulare
 Tracolla regolabile
 Misura cm. 39x29x8
 Materiale poliestere 600 D
 Stampa serigrafica

QUADRICOMIA a richiesta



area stampa cm. 19x7



04 verde



07 arancio



10 blu royal



TASCA INTERNA





02 nero

08 grigio

10 blu royal

846 BORSA PORTADOCUMENTI "CITY"

Doppia tasca con cerniera

Tasca interna

Misura cm. 40x27

Materiale poliestere 600 D

Stampa serigrafica

QUADRICOMIA a richiesta



area stampa cm. 28x12



04 verde





873 CARTELLA PORTADOCUMENTI

Chiusura con cerniera

Misura cm. 39x29x8

Materiale poliestere 600 D

Stampa serigrafica

QUADRICOMIA a richiesta



area stampa cm. 12x5



area stampa cm. 20x14



03 rosso



05 blu navy



24 beige

893 BORSA PORTADOCUMENTI

Chiusura con cerniera

Tasca esterna con cerniera

Agganci per Tracolla

Misura cm. 38,5x31

Materiale poliestere 600 D

Stampa serigrafica

QUADRICOMIA a richiesta



area stampa cm. 15x10



Doppio scomparto con cerniera



**ZAINI • BORSE SPORT • SACCHE ZAINETTI
FOOTING • OCCHIALI • BORSE TERMICHE
TELI PALESTRE E MARE • MARSUPI
BRACCIALETTI • PALLONGINI**



871 ZAINO PORTACOMPUTER



15"

4 tasche con cerniera
Divisioni e spallacci imbottiti
Tasca portacomputer con chiusura
Misura cm. 29x42x11
Materiale tecnico 900 D
Stampa serigrafica



area stampa cm. 16x10



10 blu royal



02 nero



08 grigio



867 ZAINO "JUST WAY"

Schienale e spallacci imbottiti

Manico e nastro da mm. 25

Misura cm. 24x41x12

Materiale tessuto ripstop impermeabile
idrorepellente foderato in nylon 190T

Stampa serigrafica



area stampa cm. 10x10



08 grigio





02 nero



04 verde



10 blu royal



19 rosa



03 rosso



872 ZAINO PORTACOMPUTER



4 tasche con cerniera
 Divisioni e spallacci imbottiti
 Tasca portacomputer con chiusura
Misura cm. 33x46x16
Materiale tecnico 900 D
Stampa serigrafica



area stampa cm. 16x10

Stampa laser su targhetta metallica



area stampa cm. 4,5x0,8

**SCHIENALE
IMBOTTITO**



08 grigio



02 nero





879 ZAINO "BIGGER"

Tasche attrezzate
3 tasche con cerniera
Interno e spallacci imbottiti
Tiralampo ad anello in gomma
Misura cm 33 x 46 x 16
Materiale poliestere 600D
Stampa serigrafica

QUADRICOMIA a richiesta



area stampa cm. 10x8



02 nero



10 blu royal



05 blu navy



08 grigio

**SCHIENALE
IMBOTTITO**

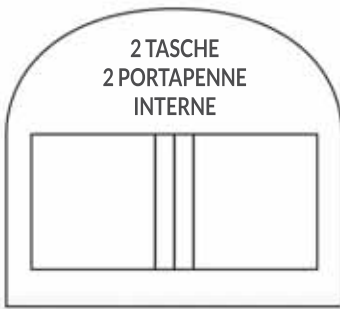



890 ZAINETTO BACK PACK

Spallacci imbottiti
Attacchi rinforzati
Manici con bottone
Misura cm. 28x39x12
Materiale nylon 600 D
Stampa serigrafica



area stampa cm. 12x10



02 nero



03 rosso



05 blu navy



10 blu royal



32 grigio scuro



21 verde mela





868 ZAINO "YUPPIE"

Tasca con cerniera
taschino con cerniera
collegato a uscita passacavi
2 tasche esterne con retina
Misura cm 30 x 18 altezza cm 40
Materiale poliestere 600D
Stampa serigrafica

QUADRICOMIA a richiesta



area stampa cm. 10x8



PZ x CARTONE

CONFEZIONE

50

10



01 bianco



02 nero



05 blu navy



06 giallo fluo



07 arancio fluo



10 blu royal



21 verde mela



27 fuxia



839 MINI BORSELLO TRACOLLA

2 Tasche con cerniera

Passante per cintura

Tracolla regolabile con moschettoni

Misura cm. 10x11x7

Materiale poliestere 420 D

Stampa serigrafica

QUADRICOMIA a richiesta



area stampa cm. 4,5x3



02 nero

03 rosso

10 blu royal

21 verde mela

24 beige



07 arancio





866 **TASCONE PORTABLET** 

Tasca portatablet imbottita
 2 tasche con cerniera
 Tracolla regolabile
 Misura cm. 24x28x4,5
 Materiale poliestere 600 D
 Stampa serigrafica
QUADRICOMIA a richiesta



area stampa cm. 5,5x7



02/07
nero/arancio



02/10
nero/blu royal



23/24
verde/beige





855 SACCA - ZAINO

Misura diam. cm 26 - alt. cm 48

Materiale tnt



area stampa cm. 20x20

PZ x CARTONE

250

CONFEZIONE

50

05 blu navy



01 bianco



06 giallo



03 rosso





894 TRACOLLA CANVAS

Pattina con chiusura a velcro
Tracolla regolabile
Misura cm 25 x 31 x 5
Materiale cotone pesante "canvas"
Stampa serigrafica

QUADRICOMIA a richiesta



area stampa cm. 15x16



829 ZAINO IN COTONE

Misura cm 36 x 46
Materiale cotone ecrù gr.125
Stampa serigrafica

QUADRICOMIA a richiesta



area stampa cm. 21x29





832 ZAINO CON RINFORZO

Angoli rinforzati in pvc
Occhielli in metallo
Misura cm 35 x 42
Materiale poliestere 190 T
Stampa serigrafica

QUADRICOMIA a richiesta



area stampa cm. 20x23



21 verde mela



02 nero



03 rosso



04 verde



05 blu navy



06 giallo



07 arancio



08 grigio



10 blu royal



12 bordeaux



14 azzurro



831 ZAINO CON RINFORZO

Laccio colorato
 Angoli rinforzati in PVC
 Laccetti in tinta
 Occhielli in metallo
 Misura cm 36 x 42
 Materiale poliestere 190 T
 Stampa serigrafica

QUADRICOMIA a richiesta



SUBLIMATICA





836 ZAINO CON LACCI

Misura cm 37 x 41
Materiale TNT gr. 80
Stampa serigrafica



area stampa cm. 20x23

PZ x CARTONE

200

CONFEZIONE

50



01 bianco



02 nero



03 rosso



05 blu navy



06 giallo



14 azzurro



21 verde mela



986 TELO PALESTRA BICOLORE

Specifico per un'ultrassorbenza
Misura cm 30 x 80
Stampa serigrafica



area stampa cm. 26x10

MICROFIBRA 100%	GRAMMI 250	PZ x CARTONE 200	PZ x BUSTA 50
-------------------------------	--------------------------	--------------------------------	-----------------------------



03 rosso

08 grigio



14 azzurro

21 verde mela



984 TELO PALESTRA

Fascia rasata per la personalizzazione
Misura cm 35x100
Stampa serigrafica



area stampa cm. 30x4,5

COTONE 100%	GRAMMI 380	PZ x CARTONE 60	PZ x BUSTA 10
---------------------------	--------------------------	-------------------------------	-----------------------------



07 arancio

21 verde mela



985 TELO PALESTRA

Ultrasorbente
Misura cm 40x100
Stampa serigrafica



area stampa
cm. 30x10



01 bianco

02 nero

10 blu royal

980 **TELO MARE**

Ultrassorbente
Misura cm 75x150
Stampa serigrafica



area stampa cm. 40x20



MICROFIBRA 	GRAMMI 200	PZ x CARTONE 40	PZ x BUSTA 5
-----------------------	--------------------------	-------------------------------	----------------------------



03 rosso



06 giallo



10 blu royal





857

**ZAINO
ANDREA MILANI**

Tasca con cerniera
Tasca frontale con cerniera
Bordino catarifrangente
Tracolle imbottite regolabili
Schienale imbottito
Misura cm 29 x 37 x 14
Materiale poliestere 600 D
Stampa serigrafica

QUADRICOMIA a richiesta

area stampa cm. 17x8

area stampa cm. 23x7,5

**IMPUGNATURA ERGONOMICA****PIPING CATARIFRAGENTE****CURSORE FIRMATO**

01 bianco

869

BORSONE SPORT

Doppie tasche laterali con cerniera
Tracolla con moschettoni regolabile
Cursori in metallo con tiralampe in poliestere
Misura cm 54 x 36 x 28
Materiale poliestere 600 D



area stampa cm. 16x10



10 blu royal



03 rosso

02 nero



875 SACCA ZAINO

Completo di scarpiera rigida (H= cm 11)
 munita di chiusura con bottoni (già inserita)
 Tasca con cerniera sul davanti
 Tracolle imbottite regolabili
 cursori in metallo con tiralampe in poliester
 Piedini in plastica
Misura cm 35 x 45 x 23
Materiale poliestere 600 D
Stampa serigrafica

QUADRICOMIA a richiesta



area stampa tasca cm. 20x9

area stampa scarpiera cm. 25x7



870 BORSONE SPORT

Completo di scarpiera rigida (H= cm 13)
 munita di chiusura con bottoni (già inserita)
 Tasca con cerniera sul davanti
 Tracolle con moschettoni regolabili
 cursori in metallo con tiralampe in poliester
 Piedini in plastica
Misura cm 50 x 44 x 29
Materiale poliestere 600 D
Stampa serigrafica



area stampa tasca cm. 28x14

area stampa scarpiera cm. 38x8





747 BORRACCIA IN ACCIAIO INOSSIDABILE

Capacità 500 ml

Ideale per palestre

In astuccio

Misura diam. = cm 7,1 h = cm 21,6

Materiale acciaio inox

Stampa serigrafica monocolore
laser - digitale

Astuccio
compreso



SERIGRAFICA
area stampa:
altezza cm. 6
circonferenza
180° = 15 cm



DIGITALE
e LASER
area stampa: cm. 6 x 2,5



09 silver



21 verde mela

BORRACCIA



Idonea a contenere
bevande gassate



751 BORRACCIA IN ACCIAIO INOSSIDABILE

Capacità 750 ml

Ideale per tempo libero e palestre

In astuccio

Misura diam. = cm 7,5 h = cm 26

Materiale acciaio inox

Stampa serigrafica monocolore
laser - digitale

Astuccio
compreso



SERIGRAFICA
area stampa:
altezza cm. 7
circonferenza
180° = 16,5 cm



DIGITALE
e LASER
area stampa: cm. 6 x 2,5



02 nero



09 silver



10 Royal



742

THERMOS IN ACCIAIO INOSSIDABILE

Doppia parete
Capacità 500 ml

In astuccio

Misura diam. = cm 7,1 h = cm 26,5

Materiale acciaio inox

Stampa serigrafica monocolor
laser - digitale

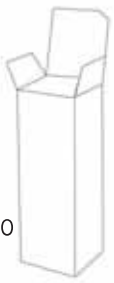

Astuccio
compreso



SERIGRAFICA
area stampa:
altezza cm. 9
circonferenza
180° = 15 cm



DIGITALE
e LASER
area stampa: cm. 9 x 2,5



**Idonea a contenere bevande
bevande gassate fredde/calde**

THERMOS



02 nero



21 verde mela



10 Royal



743 THERMOS IN ACCIAIO DA 500 ML

In acciaio inox
Capacità 500 ml

In astuccio

Misura diam. = cm 7,1 h = cm 26,5

Materiale acciaio inox con doppia parete isolante

Stampa sublimatica 1/4 colori



area stampa: altezza cm. 8
circonferenza 180° = 15 cm



Astuccio
compreso

VERNICIATURA RESINATA
IDEALE PER LA
STAMPA
IN
SUBLIMAZIONE



idonea a contenere
bevande gassate
fredde/calde



VERNICIATURA RESINATA
IDEALE PER LA
STAMPA
IN
SUBLIMAZIONE



idonea a contenere
bevande gassate
fredde/calde



748 BORRACCIA IN ACCIAIO DA 500 ML

In acciaio inox
Capacità 500 ml

In astuccio

Misura diam. = cm 7,1 h = cm 21,6

Materiale acciaio inox

Stampa sublimatica 1/4 colori



area stampa: altezza cm. 6
circonferenza 180° = 15 cm



Astuccio
compreso



739 BORRACCIA 500 ML

In alluminio con tappo a vite e moschettone
 Capacità massima 500 ml
 Astuccio a richiesta
 Misura diam. = cm 7 h = cm 19
 Materiale alluminio
 Stampa sublimatica 1/4 colori



area stampa: altezza cm. 9
 circonferenza 180° = 13 cm



**VERNICIATURA
 RESINATA
 IDEALE PER LA
 STAMPA
 IN
 SUBLIMAZIONE**

732

**TAPPO DISPENCER
 PER BORRACCIE
 A RICHIESTA**





746 BORRACCIA IN R PET

Capacità 500 ml

Cappuccio con chiusura automatica

Misura diam. = cm 6,5 h = cm 21

Stampa serigrafica



area stampa: cm.8x12



18 trasparente

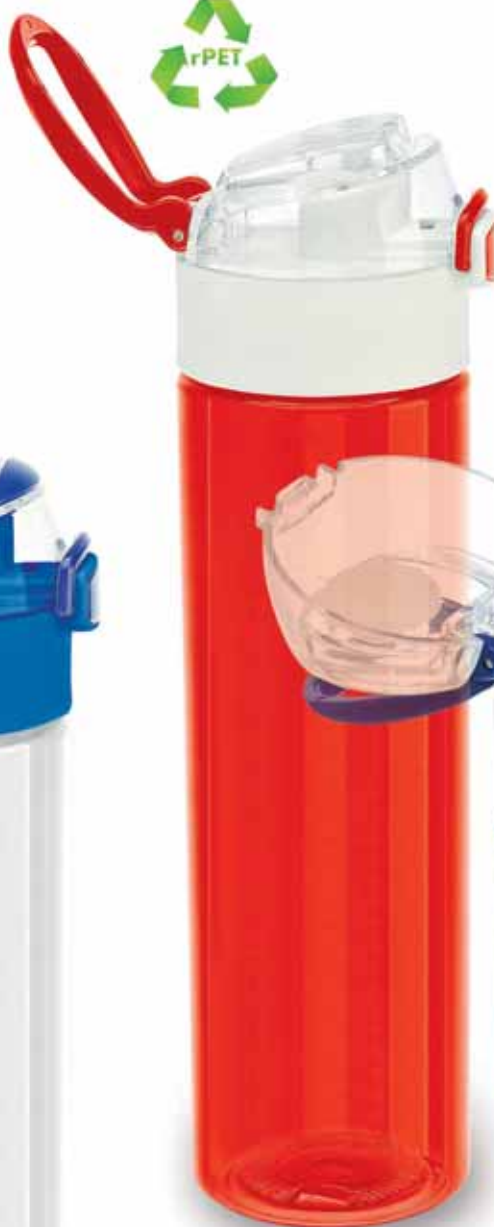

03 rosso



04 verde

10 blu royal



740 BORRACCIA 600 ML

In alluminio
Tappo a vite
Astuccio a richiesta
Misura diam. = cm 7,2 h = cm 21
Materiale alluminio
Stampa serigrafica monocolore
laser - digitale

04 verde



732 TAPPO DISPENSER
PER BORRACCE
A RICHIESTA



area stampa:
altezza cm. 9
circonferenza
180° = 15,5 cm



DIGITALE
e LASER
area stampa:
cm. 9 x 2,5



01 bianco



07 arancione



09 silver





736 BORRACCIA 500 ML

In alluminio con tappo a vite
e moschettone colorato

Astuccio a richiesta

Misura diam. = cm 7 h = cm 19

Materiale alluminio

Stampa serigrafica monocolore
laser - digitale



area stampa: altezza cm. 9
circonferenza 180° = 15 cm

DIGITALE e LASER
area stampa: cm. 9 x 2,5



732 TAPPO DISPENSER PER BORRACCIE A RICHIESTA



04 verde



01 bianco



05 blu navy



09 silver



07 arancione



741 BORRACCIA 400 ML

In alluminio con tappo a vite e moschettone colorato

Misura diam. = cm 6,5 h = cm 17,5

Materiale alluminio

Stampa serigrafica monocolor
laser - digitale



09 silver



area stampa:
altezza cm. 9
circonferenza
180° = 13 cm



DIGITALE
e LASER
area stampa:
cm. 9 x 2,5



07 arancione



04 verde



01 bianco



05 blu navy



732 TAPPO
DISPENCER
PER BORRACCIE
A RICHIESTA

ACCESSORI BORRACCE

732 TAPPO DISPENCER PER BORRACCE

Misura diam. cm 5 x 12

Materiale plastica



1003 BOX

Astuccio per borracce 500/600 ML

Materiale cartoncino bianco/bianco gr.425





865 BORSA TERMICA PORTAVIVANDE

Vassoio in plastica 3 scomparti con coperchio
 Forchetta e coltello in plastica
 Interno in pvc argentato
 Misura cm. 23x15x26
 Materiale poliestere 70 D
 Stampa serigrafica

QUADRICOMIA a richiesta



area stampa cm. 12x3,5



07 arancio



864 BORSA FRIGO ALTA CAPACITA' (12 LATTINE)

Tasca esterna
 Tasca laterale con retina
 Tracolla regolabile
 Interno in pvc argentato
 Misura cm. 23 x 15 x 26
 Materiale poliestere 70 D
 Stampa serigrafica



area stampa cm. 12x10



04 verde

07 arancio



10 blu royal





841

PORTACELLULARE PORTAOGGETTI IMPERMEABILE

Doppia chiusura ermetica e con velcro

Laccio regolabile con fermo

Misura cm. 22,8x9,4 (aperto)

cm. 18,5x9,4 (chiuso)

Materiale pvc

Stampa serigrafica



area stampa cm. 5,5x9



Pz x CARTONE

CONFEZIONE

500

50



01 bianco

03 rosso



06 giallo

04 verde



10 blu royal

ABBINABILE ALLA MASCHERINA
COD. B010
(può contenere max Pz3)



682 OCCHIALI DA SOLE

Lenti protezione UV
Misura cm. 14,3x4,7x3
Materiale pvc
Stampa serigrafica



area stampa cm. 4,5x0,8

PZ x CARTONE	CONFEZIONE
250	10



01 bianco

683 OCCHIALI DA SOLE PIEGHEVOLI

Lenti protezione UV
Misura cm. 14,3x4,7x3
Materiale pvc
Stampa serigrafica



area stampa cm. 4,5x0,8

PZ x CARTONE	CONFEZIONE
250	10



02 nero



14 azzurro



01 bianco



581 PALLONE GIGANTE

Completo di clip di sicurezza

Misura diam. cm. 150

Materiale lattice

Stampa serigrafica

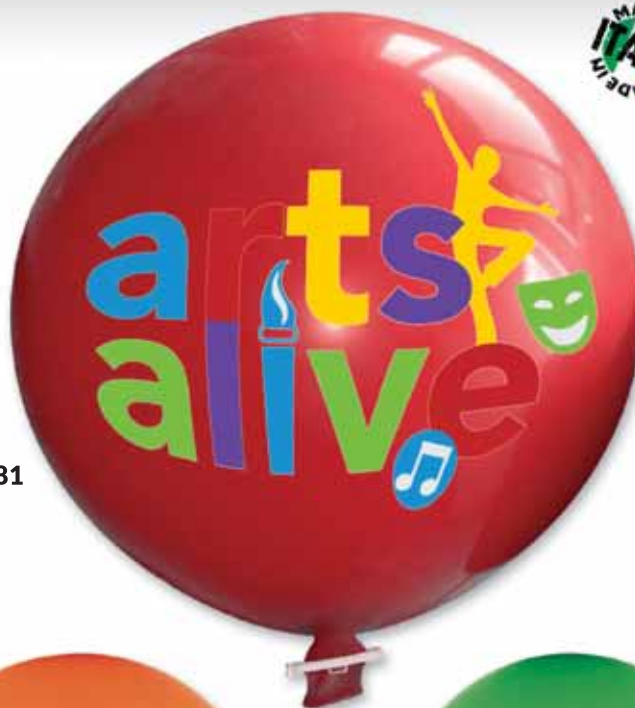

581

553 PALLONCINI CON ASTINA E VALVOLA

Misura diam. cm. 32

Materiale lattice

Stampa serigrafica



553



552

552 PALLONCINI SENZA ASTINA E VALVOLA

Misura diam. cm. 32

Materiale lattice

Stampa serigrafica



547 PALLONCINI CUORE SENZA ASTINA E VALVOLA

Misura diam. cm. 28

Materiale lattice

Stampa serigrafica



554

547
548

clip di sicurezza



548 PALLONCINI CUORE CON ASTINA E VALVOLA

Misura diam. cm. 28

Materiale lattice

Stampa serigrafica



554 POMPA PER PALLONCINI

Misura diam. cm. 5,5 - altezza cm. 44

Materiale plastica

Stampa serigrafica





627 BRACCIALETTO IN SILICONE

Anallergico
Misura unica - Larghezza mm. 12
Materiale plastica fluo
Stampa serigrafica



- 01 bianco
- 02 nero
- 03 rosso
- 04 verde
- 06 giallo
- 07 arancio
- 10 blu royal
- 19 rosa
- 20 viola
- 27 fuxia

ACCESSORI AUTO





377 PORTACHIAVI SMART BICOLORE

Gancio e anelli smaltati neri
Cucito

Misura mm 22x75 + anello

Materiale carbonio bicolore e metallo

Stampa laser / digitale



area stampa mm. 12x16



06 giallo



14 azzurro



21 verde mela



27 fuxia



378 PORTACHIAVI SMART BLACK CARBONIO

Gancio e anelli smaltati neri

Cucito

Misura mm 22x75 + anello

Materiale carbonio e metallo

Stampa laser / digitale



area stampa mm. 12x16



PZ x CARTONE

CONFEZIONE

250

50



02 nero



08 grigio



09 argento



10 blu royal

47 rame



376 PORTACHIAVI SMART FASCIA CARBONIO

02 nero

Incavo per etichetta

Cucito

Misura mm 22x75 + anello

Materiale carbonio e metallo

Stampa etichetta resinata

QUADRICOMIA a richiesta



area stampa mm. 12x16



09 argento



08 grigio



10 blu royal



47 rame





375 PORTACHIAVI SMART CRISTAL DROP

Incavo per etichetta

Cucito

Misura mm 22x75 + anello

Materiale pelle termovirante e metallo

Stampa etichetta resinata



area stampa mm. 12x16



02 nero



03 rosso



13 marrone



05 blu navy



26 salmone



15 cuoio



43 verde acido



374 PORTACHIAVI SMART IN PELLE

Cucito

Misura mm 22x75 + anello

Materiale pelle termovirante e metallo

Stampa laser / digitale



area stampa mm. 35x12



area stampa mm. 12x16



02 nero



03 rosso



05 blu navy



13 marrone



15 cuoio



26 salmone



43 verde acido



383 PORTACHIAVI MARCHI AUTO

Completo di dischetto resinato marchi auto
Cucito

Misura mm 33x70 + anello

Materiale cuoio rigenerato termovirante e metallo

Stampa a fuoco

**Stampa
a Fuoco**



area stampa mm. 70x14



area stampa mm. 18x25



02 nero



03 rosso



05 blu navy



15 cuoio



43 verde acido



26 salmone



13 marrone





305 PORTACHIAVI CON MOSCHETTONE E BOTTONE

Cucito

Doppio passante in metallo

Misura mm 85x55

Materiale cuoio rigenerato e metallo

Stampa serigrafica

QUADRICOMIA a richiesta



area stampa mm. 40x20



PZ x CARTONE

CONFEZIONE

200

50



02 nero



21 verde mela



13 marrone

337 PORTACHIAVI SAPONETTA

Cucito

In astuccio

Misura mm 33x67 + anello

Materiale ecopelle e metallo

Stampa laser



area stampa mm. 10x35



PZ x CARTONE

CONFEZIONE

250

50



02 nero



10 blu royal



300 PORTACHIAVI "BIG" IN COAGULATO FLUO

Cucito
Misura mm 90x30 + anello
Materiale coagulato fluo

**Stampa
a Fuoco**



area stampa mm. 35x18



06 giallo

14 azzurro

21 mela verde

27 fuxia

302 PORTACHIAVI "BIG" IN TAM

Cucito
Misura mm 90x30 + anello
Materiale TAM gommato
Stampa serigrafica



area stampa mm. 35x18



02 nero

03 rosso

05 blu navy

08 grigio



303 PORTACHIAVI "SMALL" IN COAGULATO FLUO

Cucito
Misura mm 83x25 + anello
Materiale coagulato fluo

Stampa
a Fuoco



area stampa mm. 45x18



06 giallo

14 azzurro

21 mela verde

27 fuxia

304 PORTACHIAVI "SMALL" IN TAM

Cucito
Misura mm 83x25 + anello
Materiale TAM gommato
Stampa serigrafica



area stampa mm. 45x18



02 nero

03 rosso

05 blu navy

08 grigio



381 PORTACHIAVI SHORT

Cucito

Misura mm 30x75 + anello

Materiale cuoio rigenerato termovirante

Stampa
a Fuoco



area stampa mm. 35x10



02 nero



03 rosso



05 blu navy



13 marrone



15 cuoio



26 salmone



43 verde acido



380 PORTACHIAVI SILHOUETTE

Cucito

Misura mm. 25x85 + anello

Materiale cuoio rigenerato termovirante



area stampa mm. 56x18



02 nero



03 rosso



05 blu navy



13 marrone



26 salmone



15 cuoio



43 verde acido



348 PORTACHIAVI DOUBLE

Passante in metallo nichel

Cucito

Misura mm 35x80 + anello

Materiale tam gommato bicolore

Stampa serigrafica



area stampa cm. 40x18



08 grigio / 02 nero



08 grigio / 05 blu navy



03 rosso / 02 nero



02 nero / 03 rosso



05 blu navy / 08 grigio



03 rosso / 08 grigio





396 PORTACHIAVI DOUBLE

Cucito
Doppio passante in metallo
Misura mm 35x80 + anello
Materiale cuoio rigenerato termovirante e TAM



Stampa
a Fuoco



area stampa mm. 40x18



05 blu navy / 08 grigio



03 rosso / 08 grigio



02 nero / 08 grigio

349 PORTACHIAVI DOUBLE

Cucito
Passante in metallo nichel
Misura mm 35x80 + anello
Materiale tam gommato
Stampa serigrafica



area stampa mm. 40x18



02 nero



03 rosso



05 blu navy



08 grigio



353 PORTACHIAVI IN METALLO CON CORDA

In bustina PVC

Misura mm 28x65x6 + anello

Materiale metallo e poliestere

Stampa laser / digitale

QUADRICOMIA a richiesta



area stampa mm. 32x18



02 nero

06 giallo

04 verde

355 PORTACHIAVI

PERSONALIZZAZIONE IN FUSIONE

Misura a richiesta

Materiale metallo nikel

Stampa smaltatura a richiesta





352 PORTACHIAVI IN METALLO CON CORDA

In bustina PVC

Misura mm 30x60x6 + anello

Materiale metallo e poliestere

Stampa laser / digitale

QUADRICOMIA a richiesta



area stampa mm. 20x33



02 nero



10 blu royal



03 rosso



319 PORTACHIAVI CON STRASS

Strass ornamentali incastonate
In astuccio

Misura mm 18x48 + anello

Materiale metallo + strass

Stampa laser



area stampa mm. 40x12



309 PORTACHIAVI CAMPO CALCIO

Pallone girevole utilizzabile come gettone per carrello supermercato
In astuccio

Misura mm 25x50 + anello

Materiale metallo lucido e laccato

Stampa laser



area stampa mm. 35x18



**UTILIZZABILE
COME
GETTONE**



343 PORTACHIAVI IN METALLO CON CLIP NIKEL

In bustina PVC con cartoncino

Misura mm 30x40

Materiale alluminio e

plastica metalcristata

Stampa laser / serigrafica



area stampa mm. 25x25

14 azzurro



02 nero



03 rosso



21 verde mela

344 PORTACHIAVI CLIP BLACK

In bustina PVC con cartoncino

Misura mm 30x40

Materiale alluminio e

plastica metalcristata

Stampa laser / serigrafica



area stampa mm. 25x25



06 giallo



07 arancio



316 PORTACHIAVI IN FELTRO

Occhio in metallo
 Anello brisè in acciaio diam. mm.30
 Misura mm 140x30
 Materiale feltro
 Stampa serigrafica
QUADRICOMIA a richiesta



area stampa mm. 90x22



01 bianco



02 nero



03 rosso



06 giallo



10 blu royal



14 azzurro



21 verde mela





315 PORTACHIAVI IN TESSUTO A RILIEVO RICAMATO

Occhiello in metallo

Anello brisé in acciaio diam. mm.30

Misura mm 130x30 + anello

Materiale tessuto poliestere

Stampa serigrafica a rilievo

 area stampa mm. 100x20



01 bianco



02 nero



03 rosso



06 giallo



10 blu royal



14 azzurro



507 PORTADOCUMENTI AUTO

Cucito

Bottone nichel

Misura mm 200 x 130

Materiale tam gommato 16/10

Stampa serigrafica

QUADRICOMIA a richiesta



area stampa mm. 130x30



08 grigio



02 nero



05 blu navy

349 PORTACHIAVI DOUBLE

Cucito

Passante in metallo nichel

Misura mm 35 x 80 + anello

Materiale tam gommato

Stampa serigrafica

QUADRICOMIA a richiesta



area stampa mm. 40x18



02 nero



08 grigio



05 blu navy



509 PORTADOCUMENTI AUTO

Cucito - Doppia fascia

Bottone nichel

Misura mm 200 x 130 (chiuso)

Materiale tam gommato 16/10

Stampa serigrafica



area stampa mm. 130x30



05 blu navy / 08 grigio



08 grigio / 02 nero



08 grigio / 05 blu navy

348 PORTACHIAVI DOUBLE

Cucito

Passante in metallo nichel

Misura mm 35 x 80 + anello

Materiale tam gommato

Stampa serigrafia



area stampa mm. 40x18



05 blu navy / 08 grigio



08 grigio / 02 nero



08 grigio / 05 blu navy



504 PORTADOCUMENTI AUTO

Cucito

Misura mm 195x145 (chiuso)

Materiale tam

Stampa serigrafica

QUADRICOMIA a richiesta



area stampa mm. 130x35



02 nero



05 blu navy



08 grigio



08 grigio



05 blu navy



02 nero

304 PORTACHIAVI "SMALL" IN TAM

Cucito

Misura mm 83x25 + anello

Materiale TAM gommato

Stampa serigrafica

QUADRICOMIA a richiesta



area stampa mm. 45x18





503 PORTADOCUMENTI AUTO

Cucito
 Misura mm 120x177 (chiuso)
 Materiale tam
 Stampa serigrafica
QUADRICOMIA a richiesta



area stampa mm. 80x30



02 nero

05 blu scuro

508 PORTADOCUMENTI AUTO

Cucito - Chiusura con Bottone
 Misura mm 130x165 (chiuso)
 Materiale tam
 Stampa serigrafica
QUADRICOMIA a richiesta



area stampa mm. 80x30



02 nero

05 blu navy



532

PORTADOCUMENTI CLASSIFICATORE BICOLORE - 3 ANTE - 8 TASCHE

2 Tasche f.to mm. 130 x 90

2 Tasche f.to mm. 90 x 120

4 Tasche f.to mm. 90 x 60

Misura mm 135x190 (chiuso)

mm 400x190 (aperto)

Materiale tam elettrosaldato 3/10

Stampa a rilievo a caldo



area stampa mm. 45x95



10 blu royal



03 rosso



02 nero





530 PORTADOCUMENTI CLASSIFICATORE
MONOCOLORE - 3 ANTE - 8 TASCHE

2 Tasche f.to mm. 130 x 90

2 Tasche f.to mm. 90 x 120

4 Tasche f.to mm. 90 x 60

Misura mm 135x190 (chiuso)

mm 400x190 (aperto)

Materiale tam elettrosaldato 3/10

Stampa serigrafica

QUADRICOMIA a richiesta



area stampa mm. 95x45



02 nero



03 rosso



10 blu royal





515 PORTADOCUMENTI AUTO

Misura mm. 190x130 (chiuso)

Materiale tam gommato elettrosaldato spessore 10/10

Stampa serigrafica

QUADRICOMIA a richiesta



area stampa mm. 135x30



PZ x CARTONE

CONFEZIONE

250

50



03 rosso



04 verde



08 grigio



10 blu royal



05 blu navy



880 PORTA DOCUMENTI
AUTO - VIAGGI

Chiusura con cerniera
Misura mm 320x230
Materiale poliestere 600D
Stampa serigrafica
QUADRICOMIA a richiesta



area stampa mm. 40x15



10 blu royal

04 verde

LIBRETTO
ASSICURAZIONE
DISCO SOSTA
MANUTENZIONE



PASSAPORTO
BIGLIETTI AEREO
VAUCHER





514 PORTADOCUMENTI AUTO

Rinforzi in metallo

Misura mm 190 x 130 (chiuso)

Materiale tam gommato elettrosaldato
spessore 12/10

Stampa serigrafica

QUADRICOMIA a richiesta



area stampa mm. 135x30



rinforzi
metallici



860 BUSTA PORTADOCUMENTI

Chiusura con bottone

Misura cm. 24 x 17,5

Materiale pvc trasparente

Stampa serigrafica

QUADRICOMIA a richiesta



area stampa cm. 16x5



area stampa cm. 8x4



06 giallo trasparente



10 blu royal trasparente



01 bianco trasparente





677 PARASOLE MET

Metallico bifacciale
Misura cm 145x70
Materiale PVC metallico
Stampa serigrafica



area stampa cm. 60x30



02 nero



578 CORNICE TARGA PER CICLOMOTORE

Misura mm 155x153
Materiale polipropilene verniciato
Stampa serigrafica



area stampa mm. 120x18





565 CORNICE TARGA ANTERIORE IN ALLUMINIO

Modello europeo

Misura mm 370x130x5

Materiale alluminio

Stampa serigrafica



area stampa mm. 350x13



551 CORNICE TARGA ANTERIORE AUTO

Misura mm 370x130

Materiale polistirolo anti urto

Stampa serigrafica



area stampa mm. 350x13



569 CORNICE TARGA PER MOTO

Misura mm 192x225

Materiale polistirolo anti urto

Stampa serigrafica



area stampa mm. 120x25





561 CORNICE TARGA POSTERIORE IN ALLUMINIO

Modello europeo
Misura mm 535x135x5
Materiale alluminio
Stampa serigrafica



area stampa mm. 350x13



567 CORNICE TARGA POSTERIORE AUTO

Modello europeo
Misura mm 525x130x5,5
Materiale polistirolo anti urto
Stampa serigrafica



area stampa mm. 350x130



571 CORNICE TARGA POSTERIORE AUTO

Modello europeo
Misura mm 535x135x13
Materiale polipropilene
Stampa serigrafica



area stampa mm. 350x130





527 DISCO ORARIO MAXI

Misura mm 117x150

Materiale cartoncino + bustina PVC

Stampa serigrafica

QUADRICOMIA a richiesta



area stampa fronte mm. 90x20



retro mm. 90x30

PZ x CARTONE

CONFEZIONE



FRONTE

RETRO



05 blu navy

557 PORTADOCUMENTI DUE TASCHE - PORTACARDS 3 POSTI

Spessore 3/10

Misura mm 240x190 (aperto)

Materiale PVC + cristal

Stampa serigrafica

QUADRICOMIA a richiesta



area stampa mm. 90x50

PZ x CARTONE

CONFEZIONE



05 blu navy



555 PORTADOCUMENTI

Misura mm 250x185 (aperto)
Materiale PVC spessore 3/10
Stampa serigrafica

QUADRICOMIA a richiesta



area stampa mm. 95x50

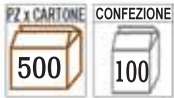

01 bianco

04 verde

05 blu navy



544 PORTASCHEDI - PORTABIGLIETTO AEREO

Misura mm 120x225 (chiuso)
Materiale PVC spessore 3/10
Stampa serigrafica

QUADRICOMIA a richiesta



area stampa cm. 8x18



05 blu navy

01 bianco





526 PORTACARDS / PATENTE 2 POSTI

Misura cm. 6 x 9 (chiuso)

Materiale tam gommato spes. 10/10 + cristal

Stampa serigrafica

QUADRICOMIA a richiesta



area stampa cm. 4,5x7,5



03 rosso



04 verde



05 blu scuro



10 blu royal





531 PORTACARDS / PATENTE 3 POSTI

Misura cm. 19,5x9,3 (aperto)

Materiale tam gommato

spes. 10/10 + cristal

Stampa serigrafica

QUADRICOMIA a richiesta



area stampa cm. 7,5x4,5



04 verde

10 blu royal

558 PORTACARDS / PATENTE 10 POSTI

Misura cm. 7 x 10 (chiuso)

Materiale tam gommato spes. 10/10 + cristal

Stampa serigrafica

QUADRICOMIA a richiesta



area stampa cm. 4,5x7,5



04 verde

05 blu scuro



528 PORTACARDS / PATENTE

Misura cm. 9x6

Materiale gommato - spessore mm. 12/10

Stampa serigrafica

QUADRICOMIA a richiesta



area stampa cm. 7,5x4,2



10 blu royal

05 blu navy

04 verde

03 rosso

524 PORTACARDS / PATENTE

Misura cm. 9,5x6,5 (aperto)

Materiale PVC spessore 2/10

Stampa serigrafica

QUADRICOMIA a richiesta



area stampa cm. 7,5x4,2



18 trasparente

04 verde



523 PORTACARDS CON PROTEZIONE RFDI

Misura cm. 9,2x6,3

Materiale alluminio - spessore mm. 1/10

Stampa serigrafica

QUADRICOMIA a richiesta



area stampa cm. 4,5x4,5



PROTEZIONE RFDI



05 blu navy



02 nero



01 bianco



03 rosso

556 CUSTODIA PER CARDS E PATENTE

Misura mm 9x5,9x0,7

Materiale Pvc morbido

Stampa serigrafica

QUADRICOMIA a richiesta



area stampa cm. 7x1,5



area stampa cm. 6x3



FRONTE

18 trasparente



RETRO



340 LANYARD PORTABADGE

Laccetto Portabadge

Misura mm 930x20 - spessore mm 1

Materiale poliestere e metallo

Stampa serigrafica



area stampa mm. 300x15



02 nero



03 rosso



04 verde



10 blu royal



08 grigio



14 azzurro





336 LANYARD PORTABADGE

Laccetto portacellulare
 Portabadge
Misura cm 93x2 spessore mm 1
Materiale poliestere e metallo
Stampa serigrafica



area stampa mm. 300x15



06 giallo

10 blu royal

14 azzurro

21 verde mela



339 LANYARD - PORTACHIAVI CON SCALA METRICA

Laccetto portacellulare
 Porta chiavetta USB snodabile
 Clip antisoffocamento
Misura mm 100x20 spessore mm1
Materiale poliestere e metallo
Stampa serigrafica

QUADRICOMIA a richiesta



area stampa mm. 290x15



06 giallo

10 blu royal





335 LANYARD

Laccetto portacellulare

Portabadge

Misura mm 930x20 - spessore mm 1

Materiale poliestere e metallo

Stampa serigrafica



area stampa mm. 300x15



01 bianco



02 nero



03 rosso



04 verde



05 blu navy



06 giallo



07 arancio



341 LANYARD CON CLIP ANTISOFFOCAMENTO

Laccetto portacellulare
Portabadge
Misura cm 93x2 spessore mm1
Materiale poliestere e metallo
Stampa serigrafica



area stampa mm. 300x15



PZ x CARTONE

CONFEZIONE

500

10

01 bianco

02 nero

05 blu navy

10 blu royal



03 rosso



332 LANYARD SUBLIMATICO

Consegna in 10 gg. lavorativi ca.

Sublimazione su entrambi i lati inclusa.
Poliestere rasato, con gancio in metallo.

Dimensioni:
lunghezza cm. 90
larghezza mm. 15
" mm. 20
" mm. 25



Sgancio
antisoffocamento
a richiesta



333 LANYARD SUBLIMATICO CON FIBBIA

Consegna in 10 gg. lavorativi ca.

Sublimazione su entrambi i lati inclusa.
Poliestere rasato, con gancio in metallo.

Dimensioni:
lunghezza cm. 90
larghezza mm. 15
" mm. 20
" mm. 25





562 BUSTINA PORTABADGE

Misura mm 66x112
Materiale PVC cristal
Stampa serigrafica



563 BUSTINA PORTABADGE

Misura mm 115x193
Materiale PVC cristal
Stampa serigrafica



564 BUSTINA PORTABADGE

Misura mm 98x82
Materiale PVC cristal
Stampa serigrafica



560 BUSTINA PORTABADGE

Misura mm 105x150
Materiale PVC cristal
Stampa serigrafica



330 CLIP PORTABADGE





360 PORTACHIAVI IN LEGNO "SQUARE"

In bustina PVC

Misura diam. mm 40x7

Materiale legno e metallo

Stampa serigrafica / laser

QUADRICOMIA a richiesta



area stampa mm. 40x20



361 PORTACHIAVI IN LEGNO "RETTANGOLO"

In bustina PVC

Misura mm. 51x32x7

Materiale legno e metallo

Stampa serigrafica / laser

QUADRICOMIA a richiesta



area stampa mm. 40x20



362 PORTACHIAVI IN BAMBÙ PORTASMARTPHONE

Universale

Misura cm 6x2,5x1,5

Materiale bambù e metallo

Stampa serigrafica/laser

QUADRICOMIA a richiesta



area stampa mm. 22x16





345 PORTACHIAVI - PORTAMONETE

Catenina metallo con anello brisé

Cucito

Misura mm 105x90

Materiale similpelle

Stampa serigrafica

QUADRICOMIA a richiesta



area stampa cm. 8x3,5



02 nero



04 verde



03 rosso



10 blu royal



306 FICHES PROFESSIONALI DA GR. 9,5

Gancio portachiavi e catenina in metallo

Misura diam mm 40

Materiale abs e metallo

Stampa serigrafica

QUADRICOMIA a richiesta



area stampa
diam. mm. 25



01 bianco

05 blu navy

328 APPENDIBORSA - PORTACHIAVI

Snodabile

Resistente fino a 5 Kg

Misura diam. mm 45 - spessore mm 9

Materiale abs

Stampa serigrafica

QUADRICOMIA a richiesta



area stampa
diam. mm. 30



05 blu navy



01 bianco



02 nero



03 rosso

314 PORTACHIAVI - PORTAGETTONI PER CARRELLO SUPERMERCATO

Anello in metallo
Misura mm 80 x 31
Materiale plastica
Stampa serigrafica

QUADRICOMIA a richiesta



area stampa mm. 50x25



01 bianco



03 rosso



21 verde mela



10 blu royal



331 PORTABADGE CUCITO

Misura mm 105x80
Materiale coagulato termovirante
Stampa serigrafica

QUADRICOMIA a richiesta



area stampa
sul retro mm. 80x45



43 verde acido



02 nero



05 blu navy



03 rosso



633 PROFUMATORE PER AUTO

Profumo fragranza limone
 Aggancio per aereatore
 Misura diam. mm 52x38
 Materiale plastica e abs
 Stampa serigrafica

QUADRICOMIA a richiesta



01 bianco



02 nero



03 rosso

711 PORTACELLULARE CON PROFUMO PER AUTO

Profumo incluso (ricaricabile)
 Aggancio per aereatore in metallo
 Misura mm 43x57x47
 Materiale abs e metallo
 Stampa serigrafica

QUADRICOMIA a richiesta

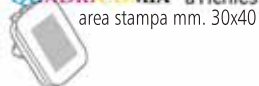

02 nero



10 blu royal





672 PORTACELLULARE PER AUTO

Braccetti mobili con aggancio automatico

Aggancio per aereatore auto

Misura cm 11x8,5

Materiale plastica e metallo

Stampa etichetta adesiva



area stampa diametro cm. 4,5



01 bianco

02 nero



01 bianco

02 nero



673 ALLARME ANTISONNO

Allarme acustico in caso di "colpo di sonno"

Entra in funzione abbassando la testa

Batterie incluse

Misura cm 3x6x2

Materiale ABS

Stampa serigrafica



area stampa diametro cm. 2,1





1070 MINI CAMION

Mini camion
 Astuccio in PVC rigido
 Misura cm 19x4,5x3
 Materiale PVC e metallo
 Stampa serigrafica/digitale
 QUADRICOMIA a richiesta



area stampa cm. 14x2,5



(ASTUCCIO)



05 blu navy



01 bianco



04 verde



03 rosso

1071 MINI PULLMAN

Astuccio in PVC rigido
 Misura cm 16x3,5x3,5
 Materiale plastica
 Stampa serigrafica/digitale
 QUADRICOMIA a richiesta



area stampa cm. 5x2

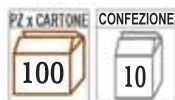

01 bianco



03 rosso



09 silver



05 blu navy



LUI & LEI



840 NECESSAIRE SATINATO CON CERNIERA

Particolari in Semipelle

Misura cm. 21x12x6

Materiale Poliestere Satinato

Stampa serigrafica



02 nero



03 rosso



10 blu royal



19 rosa



33 turchese



838 NECESSAIRE "SAHARA"

Colore unico

Misura mm 220x140x65

Materiale poliestere

Stampa serigrafica

QUADRICOMIA a richiesta



area stampa mm. 120x70



22 naturale

854 BEAUTY CASE WATER PROOF

Adatto per viaggi aerei

Misura mm 240x210x65

Materiale PVC traslucente

Stampa serigrafica

QUADRICOMIA a richiesta



area stampa mm. 150x80



03 rosso



07 arancio



10 blu royal



01 bianco



346 BORSELLINO-PORTACHIAVI "ETNICO"

Targhetta per personalizzazione

Colore unico

Misura mm 135 x 100

Materiale misto cotone

Stampa serigrafica

QUADRICOMIA a richiesta



area stampa mm. 30x20



755 NECESSAIRE "ETNICO" CON CERNIERA

Targhetta per personalizzazione

Colore unico

Misura mm 220 x 155

Materiale misto cotone

Stampa serigrafica

QUADRICOMIA a richiesta



area stampa mm. 30x20



039 PORTAMONETE METALLIC

Con cerniera

Misura cm. 12,5x9

Materiale similpelle effetto metallico

Stampa serigrafica



area stampa cm. 7x4



09 argento



19 rosa



11 oro

041 PORTAMONETE EFFETTO OLOGRAFICO

2 cerniere

Misura cm 12x8x2,2

Materiale PVC effetto olografico

Stampa serigrafica



area stampa cm. 6,5x3



09 argento

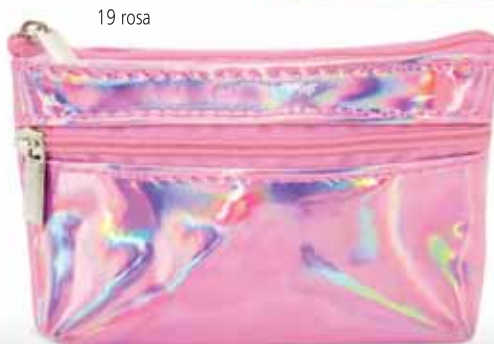

19 rosa

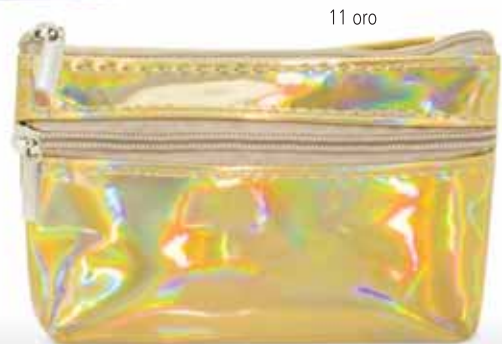

11 oro



036 SECURITY CARDS

Protezione RFDI

Custodia di sicurezza rigida per cards/soldi

Misura cm. 11x7,5x2

Materiale alluminio

6 POSTI

Stampa serigrafica

QUADRICOMIA a richiesta



area stampa cm. 5x3



**PROTEZIONE
RFDI**



**EVITA DANNEGGIAMENTI
BANDE MAGNETICHE**



- DESIGN COMODO E COMPATTO
- IMPERMEABILE
- INDISTRUTTIBILE
- SOTTILE
- SUPERLEGGERO
- IN ALLUMINIO



IMPERMEABILE



RESISTENTE



LEGGERA COME UNA PIUMA



FACILMENTE TASCABILE



03 rosso



02 nero



10 blu royal



09 silver



037 PORTAFOGLI - PORTACARDS

Con protezione RFID per carte di credito

6 tasche

In astuccio

Misura cm. 8,5x11x0,8

Materiale pelle ecologica

Stampa serigrafica o a fuoco



area stampa cm. 4,5x3



05 blu scuro



02 nero

022 PORTASOLDI PORTACARDS

Fabbricazione italiana

2 tasche portacards

Portamonete apertura a scatto

Clip fermabanconote in metallo

Misura cm. 9,5x9 (chiuso)

Materiale ecopelle

Stampa serigrafica

QUADRICOMIA a richiesta



area stampa cm. 6x3



15 cuoio

17 testa di moro

02 nero





032 PORTACARTE CREDITO - 4 POSTI

Fabbricazione italiana

4 tasche per cards

Cucito

Misura cm. 10 x 7

Materiale coagulato termovirante

Stampa serigrafica **Stampa a Fuoco**



area stampa cm. 7x2,5



08 grigio



02 nero



03 rosso



05 blu



12 bordeaux



13 marrone



43 verde acido

033 PORTACARTE CREDITO - 8 POSTI

Fabbricazione italiana

8 tasche per cards

Cucito

Misura cm. 15,5x10 (aperto)

Materiale coagulato termovirante

Stampa serigrafica **Stampa a Fuoco**



area stampa cm. 7x2,5





038 PORTACARDS 2 POSTI

Tasca frontale con pvc trasparente

Misura cm. 10,8x6,8

Materiale similpelle

Stampa serigrafica



area stampa cm. 5x5



07 arancio

04 verde

05 blu navy



03 rosso

04 verde

13 marrone

028 PORTACARTE CREDITO CON DISPENCER AUTOMATICO

Con protezione "RFID"

per carte di credito

5 posti

Chiusura calamitata

Misura cm. 7,3 x 10,5

Materiale coagulato termovirante

Stampa a fuoco



Stampa a Fuoco

area stampa cm. 6,5x2,5





034 PORTADOCUMENTI - PORTACARTE

Fabbricazione italiana
 2 tasche documenti + 3 tasche card
 Cucito
 Misura cm. 12 x 8
 Materiale coagulato - In bustina
 Stampa a fuoco **Stampa a Fuoco**



area stampa cm. 6,5x2,5

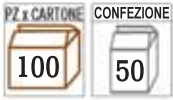

05 blu/celeste

02 nero/rosso



13 marrone/beige

025 PORTATESSERINO "ORDINI PROFESSIONALI"

Cucito, rimboccato e foderato
 Misura cm. 14,5x10,2
 Materiale coagulato termovirante
 Stampa a fuoco **Stampa a Fuoco**



area stampa cm. 4x8



02 nero

13 marrone

05 blu

03 rosso



024 PORTAFOGLI "JEANS"

Portacarte credito
 Tasca interna con cerniera portamonete
 Tasca trasparente per documenti
 Rivetti in metallo
 Misura cm. 8,5x11,5
 Materiale poliestere
 Stampa serigrafica



area stampa cm. 7x4,5



03 rosso

05 blu

24 beige

026 CINTURA BROOKLYN

Fibbia in metallo
 Regolabile in lunghezza
 Misura totale cm. 140
 Materiale 100% poliestere
 Stampa laser



area stampa cm. 3x2



01 bianco



02 nero



03 rosso



05 blu navy



07 arancio



10 blu royal



21 verde mela



24 beige



32 grigio scuro



39 verde bottiglia



345 PORTACHIAVI - PORTAMONETE

Catenina metallo con anello brisé cucito

Misura mm 105x90

Materiale similpelle

Stampa serigrafica

QUADRICOMIA a richiesta



area stampa cm. 8x3,5

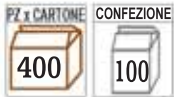

02 nero



04 verde

10 blu royal



03 rosso



035 PORTABIGLIETTINI DA VISITA

In astuccio

Misura cm. 10x6,2x1

Materiale metallo rivestito in ecopelle

Stampa serigrafica



area stampa cm. 5,5x2

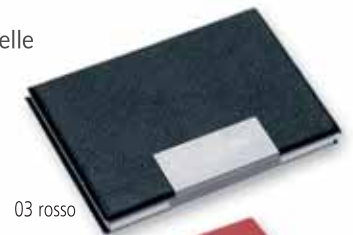

03 rosso



02 nero



PROTEZIONE
RFID



647 DOPPIO SPECCHIO CON STRASS

Specchio normale ed ingrandimento
Strass e pietre ornamentali incastonate
3 soggetti assortiti
Astuccio regalo + sacchetto in floccato
Misura diam. mm 65
Materiale metallo lucido
Stampa laser



area stampa diam. mm. 50



319 PORTACHIAVI CON STRASS

Strasse ornamentali incastonate
In astuccio
Misura mm 18x18
Materiale metallo + strass
Stampa laser



area stampa mm. 40x12

PZ x CARTONE	CONFEZIONE
250	50



313 PORTACHIAVI CON STRASS

Strass e pietre ornamentali incastonate
8 soggetti assortiti
In astuccio regalo
Materiale metallo + strass

PZ x CARTONE	CONFEZIONE
144	8





474 PENNA DIAMANTE

Fusto in plastica metalizzata

Pietra ornamentale

Movimento twist

Refill nero

Misura Lunghezza mm 140

Materiale plastica

Stampa serigrafica



area stampa mm. 35x7



09 argento

47 rame

48 multicolor



436 PENNA "ROSSETTO" CON LIQUIDO

Cappuccio colorato

Fusto ABS Trasparente con liquido

Refill nero

Misura Lunghezza mm 100 x diam. mm15

Materiale abs

Stampa serigrafica



area stampa mm. 25x15

19 rosa

01 bianco

03 rosso



652 SET MANICURE 5 PEZZI CON SPECCHIO

Custodia in abs

Misura mm 90 x 75 x 18

Materiale ABS e metallo

Stampa serigrafica

QUADRICOMIA a richiesta



area stampa mm. 30x30



10 blu royal



690 SPAZZOLA RETRAIBILE CON SPECCHIETTO

Misura diam. mm 67x24

Materiale plastica effetto metallizzato

Stampa serigrafica

QUADRICOMIA a richiesta



area stampa diam. mm. 40



27 fuxia



09 silver





328 APPENDIBORSA - PORTACHIAVI

Snodabile

Resistente fino a 5 kg.

Misura diam. mm 45 (chiuso) - spessore mm 9

Materiale abs

Stampa serigrafica

QUADRICOMIA a richiesta



area stampa diam. mm. 30



02 nero



01 bianco



03 rosso



05 blu navy



Doppia funzione

con il minimo costo





688 APPENDIBORSA

Snodabile

In astuccio cartoncino nero

Misure diam. mm. 45 (chiuso)

Materiale metallo lucido

Stampa serigrafica

QUADRICOMIA a richiesta



02 nero



03 rosso



Astuccio regalo



area stampa diam. mm. 28

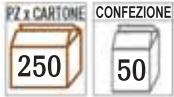

05 blu navy



656 APPENDIBORSA CON STRASS

Snodabile

strass e pietre ornamentali incastonate

3 soggetti assortiti

In astuccio regalo

Misure diam. mm. 45 (chiuso)

Materiale metallo lucido

stampa serigrafica

QUADRICOMIA a richiesta



area stampa diam. mm. 28



Astuccio regalo



702 FORBICE CON CUSTODIA

Molla di ritorno

Misura mm 120 x 15 x 10

Materiale acciaio e abs

Stampa serigrafia

QUADRICOMIA a richiesta



area stampa mm. 50x4



660 SET 4 LIME PER UNGHIE

Apribile a ventaglio

Misura mm 68 x 280 x 130

Materiale PVC

Stampa serigrafica

QUADRICOMIA a richiesta



area stampa mm. 40x16



654 TAGLIA UNGHIE PORTACHIAVI

Misura mm 50 x 17 x 15

Materiale plastica e metallo

Stampa serigrafica

QUADRICOMIA a richiesta



area stampa mm. 30x8





640

CALZASCARPE - GRATTASCHIENA

Catenina in metallo

Misura cm. 38x2,5

Materiale plastica colorata fluo trasparente

Stampa serigrafica

QUADRICOMIA a richiesta



area stampa cm. 15x1,5



03 rosso

2 SHOES

08 grigio

Zama Calzature



641

CALZASCARPE

Misura cm. 4,2x15

Materiale abs

Stampa serigrafica

QUADRICOMIA a richiesta



area stampa cm. 4,5x2,5



01 bianco

rondo calzature

03 rosso

10 blu royal

shoe store



881 PORTACAMICIA - PORTASCARPE DA VIAGGIO

Chiusura con cerniera
Misura cm. 40x25x13
Materiale tnt
Stampa serigrafica



area stampa cm. 20x8



884 PORTABITI

Richiudibile a borsa con manici
Misura cm. 60x100
Materiale tnt
Stampa serigrafica



area stampa cm. 32x20

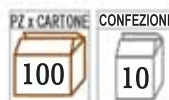



FARMACIA

CALENDARI

TERMOMETRI

PORTAPILLOLE

PORTARICETTE

CONTAPASSI

BORSE

PENNE

PORTACARDS





280 I CONSIGLI DEL FARMACISTA

Stampa off set - cm. 30x5 su tutti i fogli

QUADRICOMIA a richiesta

PZ x CARTONE

100

i Consigli del tuo Farmacista



i Consigli del tuo Farmacista

è un progetto che da anni arriva nelle vostre farmacie, sotto forma di svariati marchi o diciture, ma solo oggi finalmente avete la possibilità di poterlo acquistare senza intermediari, direttamente dal produttore.

Il Calendario

ha sempre l'obiettivo di dare utili consigli per il benessere del lettore e dei suoi cari, attraverso 12 simpatiche vignette con semplici e pratici consigli riportati da esperti farmacisti.

Il Formato

32x50 cm. 16 pagine di cui 12 per i mesi (ogni pagina contiene la testata personalizzata con i dati della farmacia, giorni del mese, santo del giorno, conteggio delle settimane, sviluppo di un tema, vignetta inerente il tema trattato), carta patinata gr. 130, stampa 4 colori fronte e retro, rilegatura con spirale.



Personalizzazione
su tutte le pagine

FARMACIA ESEMPIO

DOTT. ANDREA ESEMPIO
PRODOTTI DIETETICI E PER L'INFANZIA - OMEOPATIA - OMEOPATIA - FITOTERAPIA
MISURAZIONE PRESSIONE - AUTOANALISI DEL SANGUE - ELETTROMEDICALI

SASSUOLO - VIA MARTINI, 25 - TEL. 051.25.25.25 - INFO@MARTINFARMACIA.IT - WWW.MARTINFARMACIA.IT

Lunedì	1	19. Infezioni
Martedì	2	19. Infezioni
Mercoledì	3	19. Infezioni
Giovedì	4	19. Infezioni
Venerdì	5	19. Infezioni
Sabato	6	19. Infezioni
Domenica	7	19. Infezioni
Lunedì	8	19. Infezioni
Martedì	9	19. Infezioni
Mercoledì	10	19. Infezioni
Giovedì	11	19. Infezioni
Venerdì	12	19. Infezioni
Sabato	13	19. Infezioni
Domenica	14	19. Infezioni
Lunedì	15	19. Infezioni

GENNAIO 2024

DICEMBRE 2023							FEBBRAIO 2024						
L	M	M	G	V	S	D	L	M	M	G	V	S	D
4	5	6	7	8	9	10	11	12	13	14	15	16	17
18	19	20	21	22	23	24	25	26	27	28	29	30	31

i Consigli del tuo Farmacista



CONTROLLO DELLO STRESS

Gli effetti negativi dello stress sulla salute sono accertati: predispone alle malattie cardiovascolari, indebolisce il sistema immunitario, accelera l'invecchiamento cerebrale. La meditazione aiuta a gestire lo stress: è una pratica che, concentrandosi sul respiro, aiuta a rilassarsi e a far tacere i pensieri ossessivi, inoltre ossigena il sangue, fa abbassare la pressione e rallenta il ritmo cardiaco. Altro rimedio allo stress è il massaggio che stimola nel cervello la produzione di endorfine (gli "oppioide" naturali del sistema nervoso) e di serotonina (che mantiene stabile il tono dell'umore).

Martedì	16	19. Infezioni
Mercoledì	17	19. Infezioni
Giovedì	18	19. Infezioni
Venerdì	19	19. Infezioni
Sabato	20	19. Infezioni
Domenica	21	19. Infezioni
Lunedì	22	19. Infezioni
Martedì	23	19. Infezioni
Mercoledì	24	19. Infezioni
Giovedì	25	19. Infezioni
Venerdì	26	19. Infezioni
Sabato	27	19. Infezioni
Domenica	28	19. Infezioni
Lunedì	29	19. Infezioni
Martedì	30	19. Infezioni
Mercoledì	31	19. Infezioni

i Consigli del tuo Farmacista

PRESERVARE IL CUORE

i Consigli del tuo Farmacista

OSSERVARE IL PROPRIO CORPO

i Consigli del tuo Farmacista

EVITARE LE ALLERGIE IN CASA

i Consigli del tuo Farmacista

CONSULTARE L'ANDROLOGO

i Consigli del tuo Farmacista

ALLENARE LA MENTE

i Consigli del tuo Farmacista

PROTEGGERSI DAL SOLE

Un anno di consigli

i Consigli del tuo Farmacista

PREVENIRE LE INFEZIONI SESSUALMENTE TRASMISSIBILI

i Consigli del tuo Farmacista

I BENEFICI DEL PENSIERO POSITIVO

i Consigli del tuo Farmacista

SPENDERE LA TV E LO SMARTPHONE

i Consigli del tuo Farmacista

PROTEGGERE LE ARTICOLAZIONI

i Consigli del tuo Farmacista

REGOLARE IL VOLUME



233 SALUTE

12 fogli - carta patinata - gr. 80
 Allestimento termosaldato
 Misura formato cm. 29x47
 Stampa serigrafica - cm. 27x7,5

QUADRICOMIA a richiesta



DICEMBRE 2023 | **GENNAIO 2024** | **FEBBRAIO 2024**

IL COLESTEROLO

IL SOLE

Al 01: luce alle 8:00 tramonto alle 16:56
 Al 15: luce alle 8:00 tramonto alle 16:56
 Al 31: luce alle 7:51 tramonto alle 17:14

12 fogli - carta patinata - gr. 80
 Allestimento termosaldato
 Misura formato cm. 29x47
 Stampa serigrafica - cm. 27x7,5

QUADRICOMIA a richiesta

PZ e CARTONE 100



268 I CONSIGLI DEL FARMACISTA DA TAVOLO

13 fogli - gr. 115
 Retro con i consigli del farmacista
 Allestimento spiralato
 Misura formato cm. 19x14,5
 Stampa serigrafica - cm. 18x3

QUADRICOMIA a richiesta



Sul retro di ogni mensile,
 12 simpatiche vignette
 con semplici e pratici consigli
 riportati da esperti farmacisti.





251 TRIMESTRALE SPIRALATO

12 fogli - gr. 80
 Allestimento spiralato
 Misura formato cm. 31x44
 Stampa off-set - cm. 29x8 su tutti i fogli

QUADRICOMIA a richiesta



- 03 rosso
- 04 verde
- 10 blu royal

A richiesta
 stampa turni
 di servizio



257 TRIMESTRALE LARGE

12 fogli - gr. 80
 Allestimento termosaldato
 Misura formato cm. 29x47
 Stampa serigrafica - cm. 27x7,5

QUADRICOMIA a richiesta



- 03 rosso
- 04 verde
- 10 blu royal





403 PENNA "FARMACIA" CON CADUCEO

Refill nero

Misura Lunghezza mm 140

Materiale abs

Stampa serigrafica

QUADRICOMIA a richiesta



area stampa mm. 30x8

PZ x CARTONE

1000

CONFEZIONE

50



05 blu navy



04 verde



417 PENNA "CREAM"

Con tappo chiusura
colore unico

Misura Lunghezza mm 118 - Diam. mm 26

Materiale plastica

Refill blu

Stampa serigrafica

QUADRICOMIA a richiesta



area stampa mm. 40x10

01 bianco



448 PENNA "SIRINGA"

Misura Lunghezza mm 130

Materiale plastica

Refill nero

Stampa serigrafica

QUADRICOMIA a richiesta



area stampa mm. 35x10



03 rosso



10 blu royal



04 verde



01 bianco



470 PENNA SPRAY

Clip in metallo

Misura Lunghezza mm140

Materiale ABS in metallo

Refill nero

Stampa serigrafica

area stampa mm. 30x8

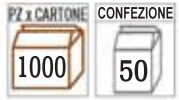

01 bianco

04 verde

05 blu navy

06 giallo

07 arancio

10 blu royal



PROFUMAZIONE



ANTIAGGRESSIONE



IGIENIZZANTE



ANTIZANZARE



100 ml



B123 GEL IGIENIZZANTE MANI ALCOOL AL 70%

Confezione pz. 50

Con etichetta personalizzabile





659 TERMOMETRO IN LEGNO AD ALCOOL

In astuccio
Misura cm 6 x 25,6
Materiale legno
Stampa serigrafica

PZ x CARTONE	CONFEZIONE
144	24

area stampa mm. 40x25

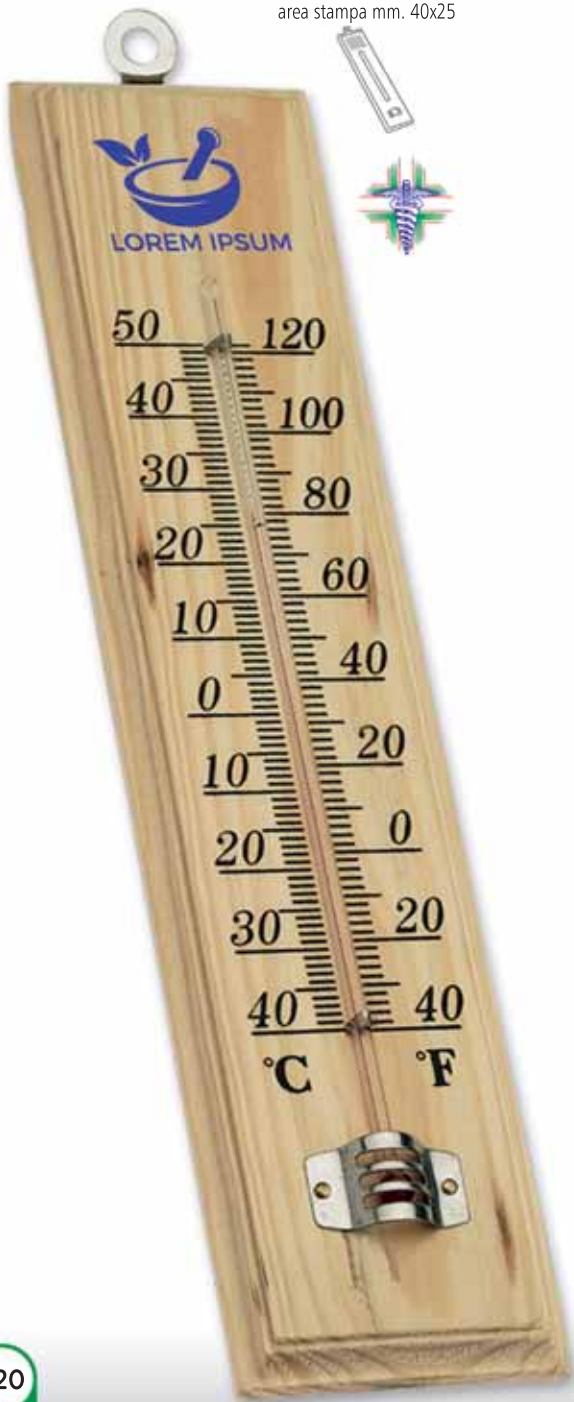

674 BOX PORTAPILLOLE 3 SCOMPARTI

Misura cm 6,4 x 3,4 x 1,4
Materiale ABS
Stampa serigrafica

QUADRICOMIA arichiesta
area stampa mm. 55x25



PZ x CARTONE	CONFEZIONE
1000	50



01 bianco

329 PORTACHIAVI - PORTAPILLOLE

Misura cm 4,5 x 5,5 x 1,4
Materiale ABS
Stampa serigrafica

QUADRICOMIA arichiesta
area stampa mm. 28x28



PZ x CARTONE	CONFEZIONE
500	100



04 verde

01 bianco

03 rosso

05 blu navy

06 giallo



670 BOX PORTAPILLOLE 4 SCOMPARTI



Vaschetta girevole con dispenser

Misura diam. cm 7 - alt cm 2,1

Materiale PVC rigido

Stampa serigrafica

QUADRICOMIA a richiesta



area stampa mm. 65x10



10 blu royal

04 verde



669 BOX PORTAPILLOLE 3 SCOMPARTI



Misura cm 6,1 x 4 x 1,3

Materiale polipropilene rigido

Stampa serigrafica

QUADRICOMIA a richiesta



area stampa cm. 5x3



04 verde

01 bianco



689 BOX PORTAPILLOLE 6 SCOMPARTI



Misura cm 8,6 x 5,9 x 2,1

Materiale polipropilene rigido

Stampa serigrafica

QUADRICOMIA a richiesta



area stampa cm. 5,5x3



10 blu royal





B121

GEL IGIENIZZANTE MANI **ALCOOL AL 70%**
CONFEZIONE PZ 8

1 LITRO



**2 DOSATORI
INCLUSI NELLA
CONFEZIONE**



B122

GEL IGIENIZZANTE MANI **ALCOOL AL 70%**
CONFEZIONE PZ 12

500 ML



**TAPPO
A
SCATTO**





B010 MASCHERINE FILTRANTI
3 STRATI

PZ x CARTONE
2000

CONFEZIONE
50



B020 MASCHERINE FILTRANTI
5 STRATI FFP2 - KN95

PZ x CARTONE
900

CONFEZIONE
20



EFFICIENZA FILTRANTE
MINIMA DEL 95%



529 CUSTODIA PER MASCHERINE 3 STRATI

2 Tasche
 Misura cm 12x12 (chiusa)
 Materiale PVC + cristal
 Stampa serigrafica



area stampa mm. 90x35



01 bianco

05 blu navy

07 arancio

10 blu royal

04 verde



522 LANYARD/PORTAMASCHERINE

Lanyard/Portamascherine
 Misura laccio mm. 930x20 - spessore mm. 1
 Misura portamascherina mm. 120x120
 Materiale PVC cartonato
 Stampa serigrafica



area stampa mm. 60x30



area stampa mm. 300x15



05 blu navy

07 arancio

10 blu royal

04 verde

01 bianco





928 BORSA IN HEAVY COTTON ECRÙ

Manici lunghi cm 70 x 2,7

Misura cm 37 x 42 ca.

Materiale cotone gr. 125

Stampa serigrafica

QUADRICOMIA a richiesta



area stampa cm. 21x29



22 naturale



709 BORSA TNT CON SOFFIETTI

Manici lunghi cm 45 x 2,5

Misura cm 38 x 42 x 10

Materiale TNT cuciture termiche gr. 80

Stampa serigrafica

QUADRICOMIA a richiesta



area stampa cm. 21x29,7



621 cm. 19x8x23

Imballo: 350

area stampa cm. 14x15*

616 cm. 22x12x29

Imballo: 350

area stampa cm. 16,5x18*

617 cm. 26x13x41

Imballo: 250

area stampa cm. 20x24*

618 cm. 32x17x45

Imballo: 250

area stampa cm. 24x28*

619 cm. 45x16x49

Imballo: 200

area stampa cm. 35x38*

* area stampa



QUADRICOMIA a richiesta



01 bianco



526 PORTATESSERA SANITARIA 2 POSTI

Misura cm 6 x 9 (chiuso)
Materiale tam gommato
spes. 10/10 + cristal

Stampa serigrafica

QUADRICOMIA a richiesta

area stampa mm. 45x75



03 rosso

04 verde

05 blu navy

10 blu royal



03 rosso

04 verde

05 blu navy

10 blu royal

528 PORTATESSERA SANITARIA

Spessore mm 12/10

Misura cm 9 x 6

Materiale gommato

Stampa serigrafica

QUADRICOMIA a richiesta

area stampa Mm. 75x42



557 PORTARICETTE - PORTATESSERA SANITARIA 3 POSTI

Spessore 3/10

Misura cm 24 x 19 (aperto)

Materiale pvc + cristal

Stampa serigrafica

QUADRICOMIA a richiesta

area stampa mm. 90x50





B162 VISIERA PROTETTIVA
IN PETG DA 500 MICRON

Sistema antidroplet
 Bottoni in metallo
 Misura cm. 32x22x3
 Peso gr. 80
 Materiale PETG 500 micron
 gomma espansa mm 30
 fascia elastica da mm 20



POSSIBILE
PERSONALIZZAZIONE
GRAFICA
A PARTIRE DA
PZ.500



B160 VISIERA PROTETTIVA
IN PET DA 1 MM



B167 VISIERA PROTETTIVA
IN PET DA 1 MM



HI-TECH





764 CALCOLATRICE 8 CIFRE "SOFT TOUCH"

Alimentazione a batterie (fornite)

Tasti multicolor

In astuccio

Misura cm. 6,3x11x0,7

Materiale plastica

Stampa serigrafica

QUADRICOMIA a richiesta



area stampa cm. 4x1,5



767 CALCOLATRICE 12 CIFRE

Dual power:

Alimentazione a batterie (fornite)

Alimentazione a cellule solari

Display reclinabile

Tasti big soft

In astuccio

Misura cm. 16,8x16,7x1,5

Materiale plastica e gomma

Stampa serigrafica

QUADRICOMIA a richiesta



area stampa cm. 4x3





1052 CHIAVETTA USB FOLDING 2 GB

1054 CHIAVETTA USB FOLDING 4 GB

1058 CHIAVETTA USB FOLDING 8 GB

1059 CHIAVETTA USB FOLDING 16 GB

1060 CHIAVETTA USB FOLDING 32 GB

In astuccio

Misura cm. 5,5x1,9x1

Materiale metallo e plastica

Stampa serigrafica/Digitale/Laser

QUADRICOMIA a richiesta

 area stampa cm. 2,5x1,5

PZ x CARTONE
100
CONFEZIONE
10



GARANZIA 1 ANNO

**PRONTA
CONSEGNA**

in astuccio



02 nero



03 rosso



04 verde



10 blu royal



1062 USB CREDIT CARD 2 GB

1064 USB CREDIT CARD 4 GB

1068 USB CREDIT CARD 8 GB

1069 USB CREDIT CARD 16 GB

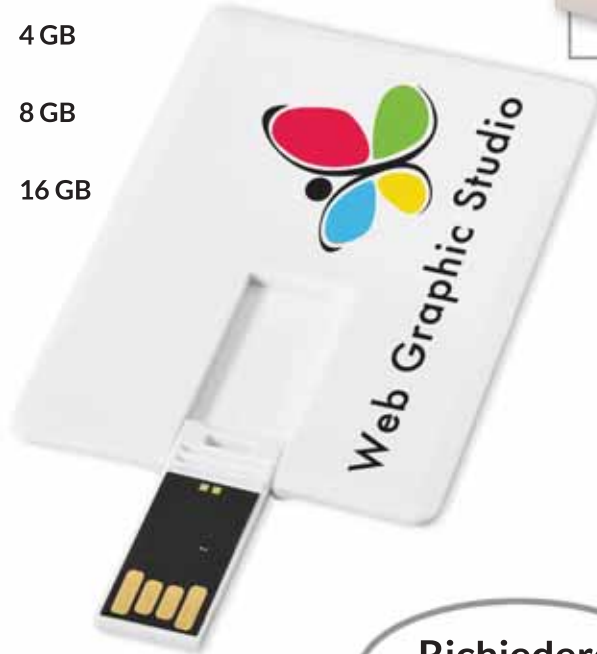

In astuccio

Misura cm. 8,2x5,2x0,2

Materiale plastica

QUADRICOMIA a richiesta



Richiedere Preventivo

1061 USB 2/3D PERSONALIZZATO

Forma e colori a richiesta

da 1 a 32 GB a richiesta

Tempi di consegna : 4 Settimane

dall' approvazione dalla foto campione

In Astuccio

Materiale Soft pvc

CREA LA TUA USB

Ordine Minimo: Pz.100





775 PORTACHIAVI - LACCIO - CARICATORE PER SMATPHONE

Misura cm. 11x1,5x1,2 (chiuso)
cm. 20,5x1,2 (aperto)

Materiale metallo e silicone
Stampa laser



02 nero



14 azzurro



area stampa cm. 2,5x0,7



776 PORTACHIAVI - LACCIO - CARICATORE PER I-PHONE

Misura cm. 11x1,5x1,2 (chiuso)
cm. 20,5x1,2 (aperto)

Materiale metallo e silicone
Stampa laser



14 azzurro



02 nero



area stampa cm. 2,5x0,7



759 ADATTATORE PRESE UNIVERSALE

In astuccio

Misura cm. 10,5x10,5x1,5

Materiale abs

Stampa serigrafica

QUADRICOMIA a richiesta



area stampa cm. 3,8x1,8





673 ALLARME ANTISONNO

Allarme acustico in caso di "colpo di sonno"

Entra in funzione abbassando la testa

Batterie incluse

Misura cm 3x6x2

Materiale ABS

Stampa serigrafica

QUADRICOMIA a richiesta



area stampa diametro cm. 2,1

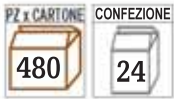

02 nero



01 bianco

758 MULTIPRESA USB + OROLOGIO + SVEGLIA

4 porte USB

In astuccio

Misura cm.12x7x4,5

Materiale abs

Stampa serigrafica

QUADRICOMIA a richiesta



area stampa cm. 10x1





738 PORTACELLULARE PER AUTO CON CALAMITA

Aggancio per aereatore auto

Misura mm 30x30

Materiale plastica e metallo colore unico

Stampa serigrafica

QUADRICOMIA a richiesta



area stampa diam. mm. 27



672 PORTACELLULARE PER AUTO CON CALAMITA

Braccetti mobili con aggancio automatico

Aggancio per aereatore auto

Misura cm 11x8,5

Materiale plastica e metallo

Stampa etichetta adesiva



area stampa diametro cm. 4,5



01 bianco

02 nero





766 POWER BANK IN ALLUMINIO 2200

Caricatore USB
 Capacità 2200 mAh
 Doppia porta entrata: USB e micro USB
 In astuccio
 Misura cm. 9,5x2,1x2,2
 Materiale alluminio
 Stampa serigrafica o incisione a laser

QUADRICOMIA a richiesta



Astuccio



713 SPINA CON ENTRATA USB

Misura cm. 2,6x2,6x4
 Materiale pvc
 Stampa serigrafica

QUADRICOMIA a richiesta

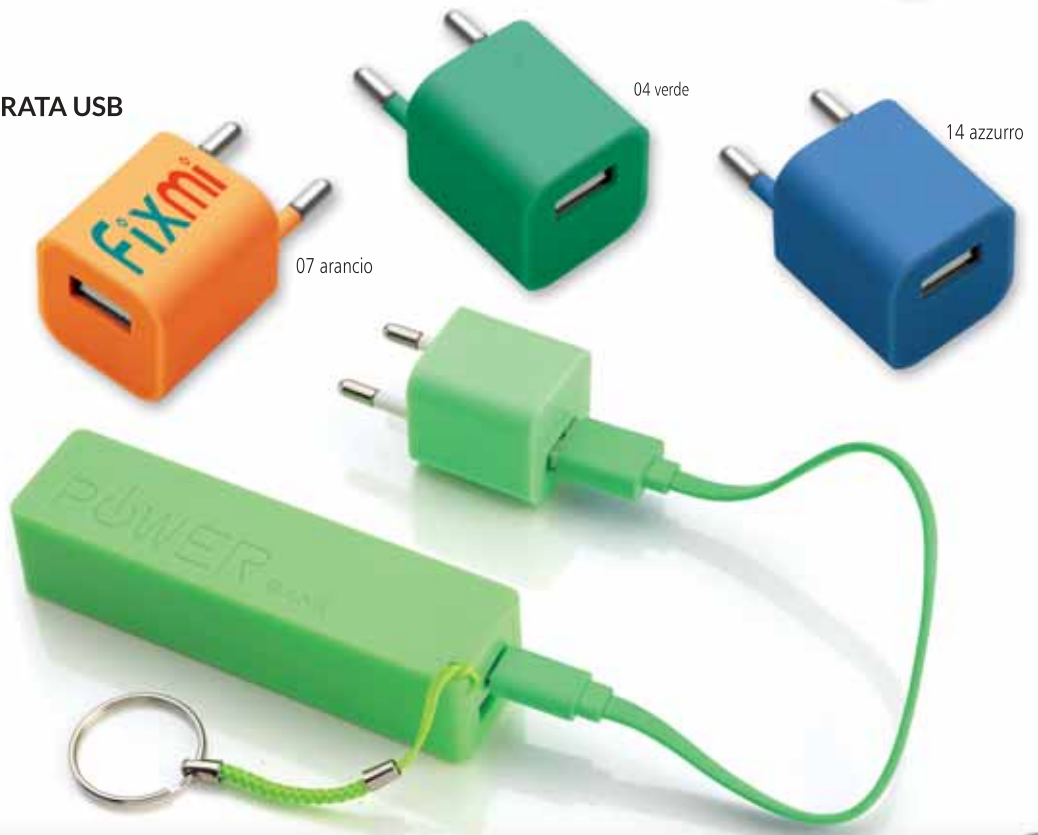
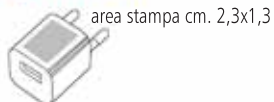



687 ANELLO ADESIVO PER CELLULARI

Misura diam. mm 35

Materiale plastica e abs

Stampa serigrafica

QUADRICOMIA a richiesta



area stampa diam. mm. 17



27 fuxia



01 bianco



02 nero



04 verde



05 blu navy



06 giallo

774 OCCHIALI REALTÀ VIRTUALE

Aggancio per telefonino

In astuccio rigido PVC

Misura cm. 13x7x2

Materiale abs

Stampa serigrafica

QUADRICOMIA a richiesta



area stampa cm. 8x3,5



661 PORTACELLULARE PORTACARDS

Utilizzabile come:
 Portacarte credito
 Base per cellulare
 Anello per selfie
 Misura cm 6x10
 Materiale ABS
 Stampa serigrafica



area stampa mm. 25x25

PZ x CARTONE

1000

CONFEZIONE

500

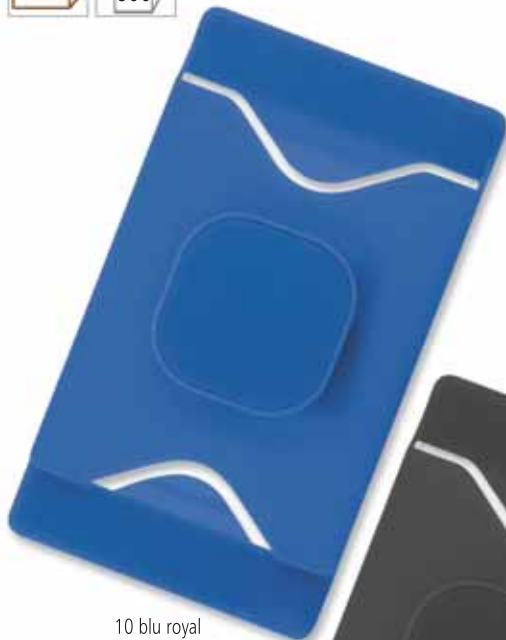
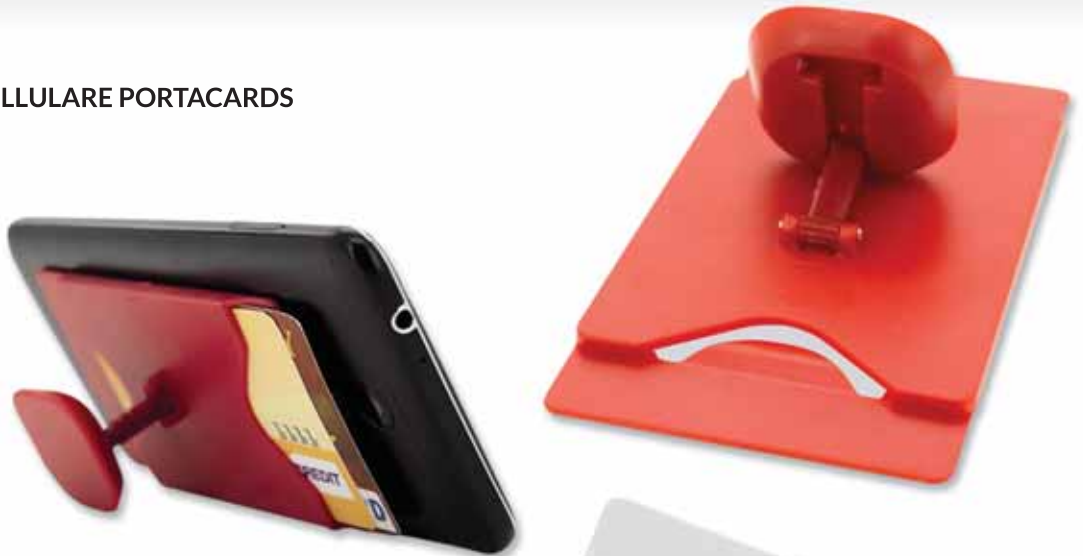

10 blu royal



01 bianco

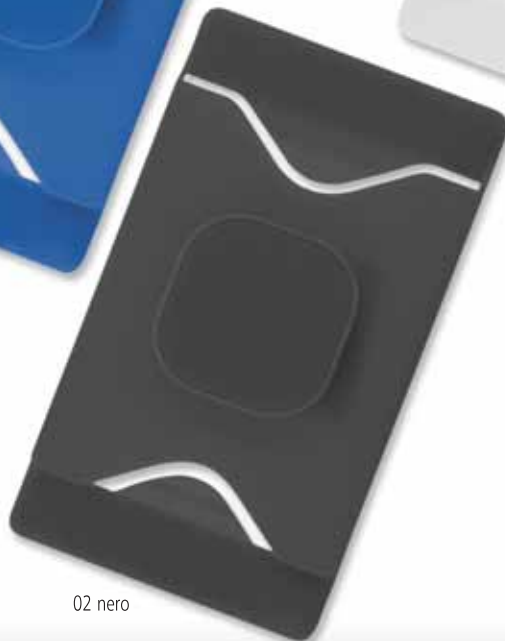

02 nero



03 rosso



777 LAMPADA - ALTOPARLANTE BLUETOOTH

Lampada da scrivania con altoparlante
 Questa lampada elegante e funzionale presenta 18 LED a forte luminosità
 Interruttore touch e braccio flessibile
 Permette la trasmissione bluetooth e stereo mm 3,5
 Con 5 W/4Ω e autonomia fino a 6h
 Permette la connessione alla play list del cellulare
 Include il cavetto USB per caricare
 Questo prodotto è fornito in scatola regalo

Misura cm. 10x10x22,5

Materiale ABS

Stampa serigrafica

QUADRICOMIA arichiesta

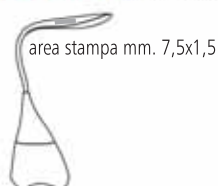

778 ALTOPARLANTE BLUETOOTH

Altoparlante portatile, con luce Led all'interno,
 in ABS e finitura in gomma (personalizzabile con logo illuminato).
 Trasmissione per bluetooth 4.2 e potenza 3W(4 Ω).
 Batteria da 300mAh e autonomia superiore a 2h.
 Include cavo 2 in 1: USB/micro USB per caricamento e micro USB/3.5 jack

Misura cm. 5,9x5,9x5,1

Materiale ABS e gomma

Stampa laser





676 LAMPADA LED PORTATILE

Accensione a scatto
Completa di Batteria (3 Pile AAA)
Corda lunga mt. 1,09
Misura Diam. cm. 5,5x16
Materiale ABS
Stampa serigrafica



area stampa cm. 4,5x3



**DAI LUCE
ALLE TUE IDEE
PROMOZIONALI**

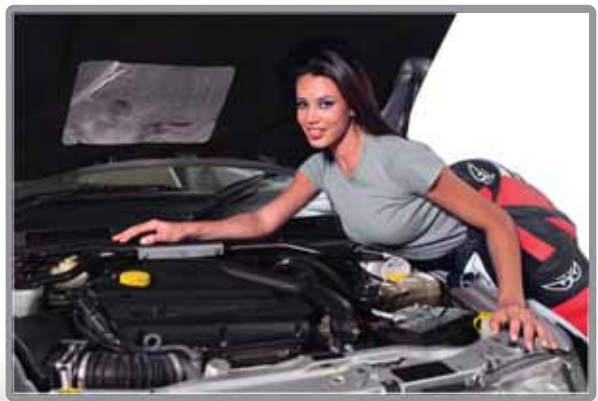

**AGGIUNGI
UN POSTO
A TAVOLA**





752

WHITE MUG

Tazza in ceramica

Ideale per la stampa sublimatica

Capacità 0,33 lt

Peso gr. 324

In astuccio cartoncino singolo con finestra

Misura diam. cm. 8 - alt. cm. 9,5

Materiale ceramica

Stampa sublimatica





570 PORTAMENÙ

16 posti
 Fermagli in metallo per aggiungere altri posti
 Cucito
 Misura cm. 16,5x25,5 (chiuso)
 Materiale cuoio termovirante
 Stampa **Stampa a Fuoco**



574 PORTAMENÙ

16 posti
 Fermagli in metallo per aggiungere altri posti
 Cucito
 Misura cm. 24x32 (chiuso)
 Materiale cuoio termovirante
 Stampa **Stampa a Fuoco**



area stampa cm. 7x9



area stampa cm. 7x9



02 nero



15 cuoio



02 nero



03 rosso



05 blu navy



13 marrone



15 cuoio



43 verde acido





566 RENDIRESTO

Pattina interna calamitata
Portapenna (penna esclusa)

Misura cm. 12,5x21 (chiuso)

Materiale cuoio rigenerato termovirante

Stampa serigrafica **Stampa a Fuoco**



03 rosso



area stampa cm. 6x2,5



COLORI DISPONIBILI



02 nero



03 rosso



05 blu navy



13 marrone



15 cuoio



43 verde acido

582 LISTA VINI

16 posti

Fermagli in metallo per
aggiungere altri posti

Cucito

Misura cm. 16,5x25,5 (chiuso)

Materiale cuoio termovirante

Stampa serigrafica **Stampa a Fuoco**



area stampa cm. 7x9



43 verde acido

583 LISTA VINI

16 posti

Fermagli in metallo per
aggiungere altri posti

Cucito

Misura cm. 24x32 (chiuso)

Materiale cuoio termovirante

Stampa serigrafica **Stampa a Fuoco**



area stampa cm. 7x9



05 blu navy



576 SOTTOBICCHIERE



Misura diam. mm 95

Materiale cuio rigenerante termovirante

Stampa **Stampa a Fuoco**



area stampa diam. mm. 65

PZ x CARTONE

CONFEZIONE

500

50



COLORI DISPONIBILI



02 nero



03 rosso



05 blu navy



13 marrone



15 cuio



43 verde acido

580 SOTTOPIATTO

Misura mm 425x305

Materiale cuio rigenerante termovirante

Stampa **Stampa a Fuoco**



area stampa mm. 100x30

PZ x CARTONE

CONFEZIONE

50

10





572 SOTTOBICCHIERE LAVABILE

Misura diam. mm. 95x1,8

Materiale Pvc idrorepellente
lavabile con supporto
cuoio rigenerato

Stampa serigrafica

QUADRICOMIA a richiesta



area stampa diam. mm. 65



55 giallo oca



02 nero



07 arancio



08 grigio



14 azzurro



24 beige



573 SOTTOPIATTO "EGG" LAVABILE

Misura mm. 335x335x1,8

Materiale Pvc idrorepellente
lavabile con supporto
cuoio rigenerato

Stampa serigrafica

QUADRICOMIA a richiesta



area stampa mm. 100x30

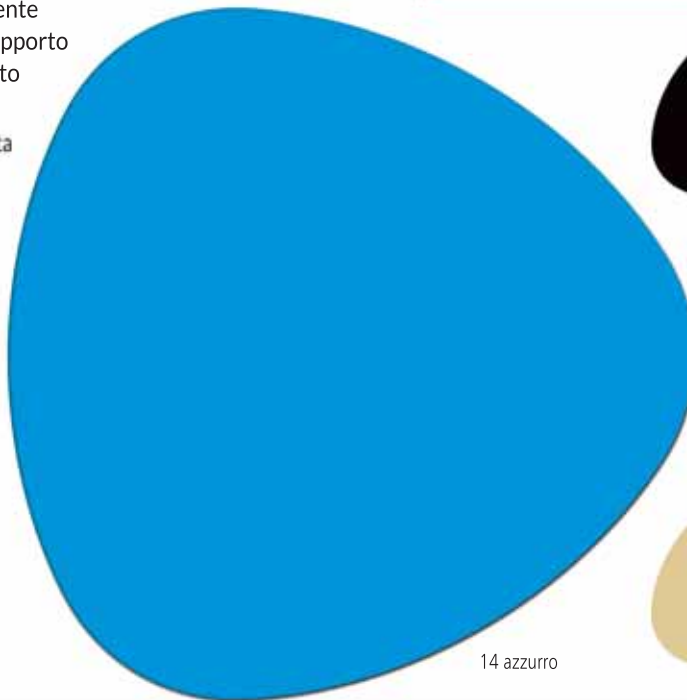

14 azzurro



02 nero



07 arancio



08 grigio



24 beige



55 giallo oca



628 TOVAGLIETTA LAVABILE
"HOME"

Con corda naturale per chiusura

Misura cm. 45x30

Materiale poliestere

Stampa serigrafica - DTF



area stampa cm. 20x10

PZ x CARTONE

150

CONFEZIONE

5



Incluso corda
di colore naturale

03 rosso

05 blu navy



734 CUSTODIA REFRIGERANTE
PER BOTTIGLIA

Chiusura con velcro

Colore unico

Misura cm. 33,8x18,2

Materiale plastica + liquidi refrigerante

Stampa serigrafica

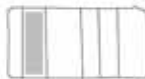

area stampa cm. 14x3,5

PZ x CARTONE

48

CONFEZIONE

12

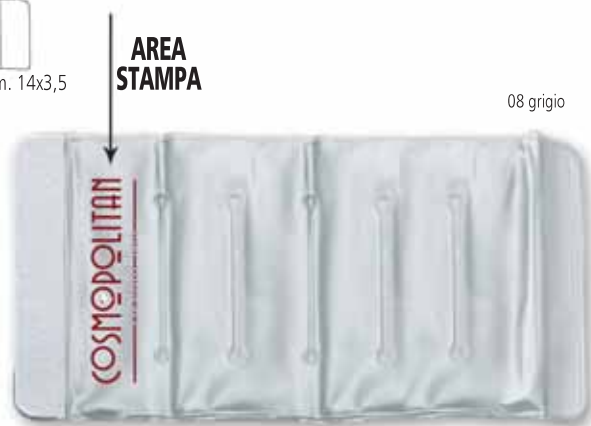

AREA
STAMPA

08 grigio





756 BOTTIGLIA - SET VINO

Completa di set in acciaio:

apribottiglia-cavatappi

+ salvagocce

+versatoio

Chiusura calamitata

In astuccio

Misura diam. cm. 6 x h. cm. 23,5

Materiale custodia in PVC e set in acciaio

Stampa serigrafica

o etichetta adesiva in quadricomia

09 silver

11 oro



03 rosso



area stampa cm. 4,5x 9





745 PORTABOTTIGLIA CON SET VINO

Capacità 0,75/1 lt.
Completa di set in acciaio:
Salvagocce
Tappo
Versatore
Apribottiglia
In astuccio
Misura cm. 36,5x11x11
Materiale legno
Stampa serigrafica



area stampa cm. 12x5



762 PORTABOTTIGLIE CON SET VINO

Capacità 0,75/1 lt.
Completa di set in acciaio:
Salvagocce
Tappo
Versatore
Apribottiglia
Levacapsule
Termometro
In astuccio
Misura cm. 36x22x12
Materiale legno
Stampa serigrafica



area stampa cm. 12x6





754

PORTABOTTIGLIA COFANETTO REGALO

Capacità 0,75/1 lt.
Riutilizzabile come beauty case
(accessori non inclusi)
In astuccio
Misura cm. 34,5x11x10



02 nero

Ecopelle effetto cocodrillo



03 rosso

744

PORTABOTTIGLIA COFANETTO CON SET VINO

Capacità 0,75/1 lt.
Completa di set in acciaio:
Salvagocce - tappo - apribottiglia
In astuccio
Misura cm. 34,5x11x10





708 SET CAVATAPPI AUTOMATICO

LED illuminazione

Supporto tagliacapsule

4 batterie AA (non incluse)

Misura diam. cm. 4,7 altezza cm. 26,5

Materiale acciaio inox e plastica

Stampa serigrafica - laser

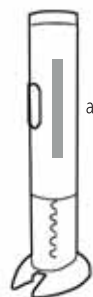

area stampa cm. 5x1



SUPPORTO
TAGLIA CAPSULE



TASTO DI
ESTRAZIONE

TASTO DI
ESPULSIONE

ZONA
ILLUMINATA

Con un design moderno ed elegante, questo comodo apribottiglie elettrico in acciaio inossidabile la aiuterà ad aprire rapidamente la sua bottiglia di vino.



707 CAVATAPPI "BOTTIGLIA
RED WINE

High quality
Aggancio snodabile
Colore unico
Magnete sul retro
In astuccio

Misura diam. cm. 2,5 - altezza cm. 11,5

Materiale ABS trasparente e acciaio

Stampa serigrafica
o etichetta adesiva in quadricomia



area stampa cm. 3,5x6



706 CAVATAPPI "BOTTIGLIA
WHITE WINE

High quality
Aggancio snodabile
Colore unico
Magnete sul retro
In astuccio

Misura diam. cm. 2,5 - altezza cm. 11,5

Materiale ABS trasparente e acciaio

Stampa serigrafica
o etichetta adesiva in quadricomia



area stampa cm. 3,5x6





700 SET APRIBOTTIGLIA 3 FUNZIONI

Coltellino levacapsule
 Cavatappi altezza regolabile
 Apribottiglia
 High quality
 In astuccio
 Misura cm. 12x2
 Materiale metallo e acciaio
 Stampa laser



area stampa cm. 5x0,7



02 nero



12 bordeaux



**AGGANCIAMENTO SNODABILE
CON ALTEZZA REGOLABILE**

698 SET APRIBOTTIGLIA 3 FUNZIONI

High quality
 In astuccio
 Misura cm. 11x2,5
 Materiale legno e metallo
 Stampa serigrafica

QUADRICOMIA a richiesta



area stampa cm. 6x0,8



13 marrone





699 APRIBOTTIGLIE "POWER"

Calamita sul retro
 Misura cm. 5x10,5x0,3
 Materiale abs e metallo
 Stampa serigrafica
 QUADRICOMIA a richiesta



area stampa cm. 5x2



01 bianco

04 verde

07 arancio

10 blu royal

CALAMITA
SUL RETRO

697 APRIBOTTIGLIE "SHARK"

Calamita sul retro
 Misura cm. 7,3x13x0,4
 Materiale abs e metallo
 Stampa serigrafica
 QUADRICOMIA a richiesta



area stampa (lato superiore) cm. 3
 (lato inferiore) cm. 1
 altezza cm. 4



CALAMITA
SUL RETRO

14 azzurro



723 TAGLIAPIZZE - APRIBOTTIGLIE

Misura cm. 13x8x2

Materiale plastica e metallo

Stampa serigrafica

QUADRICOMIA a richiesta



area stampa cm. 5,5x2



01 bianco



03 rosso



04 verde



717 TAGLIAPIZZE - APRIBOTTIGLIE

Misura cm. 13x5,5

Materiale plastica e metallo

Stampa serigrafica

QUADRICOMIA a richiesta



area stampa cm. 3,5x2



04 verde



01 bianco



03 rosso



979 PORTABOTTIGLIA GLITTER

Manici cm. 34x2,5

Misura cm. 12x36x12

Materiale laminato e glitterato gr. 140

Cuciture termiche

Stampa serigrafica



area stampa cm. 10x28

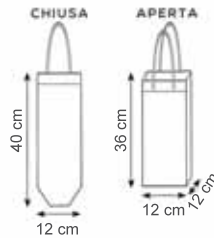

11 glitter oro

988 PORTABOTTIGLIA

Manici cm. 34x2,5

Misura cm. 13x38x10

Materiale tnt gr. 80

Cuciture termiche

Stampa serigrafica



area stampa cm. 10x28

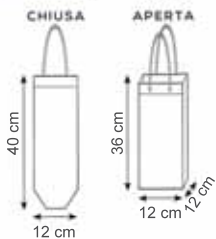
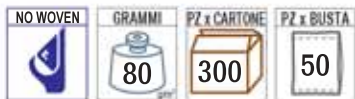

12 bordeaux



835 PORTABOTTIGLIE 2 POSTI

Con separatore interno

Misura cm. 18x34x10

Materiale tnt gr. 80

Cuciture termiche

Stampa serigrafica



area stampa cm. 14x25

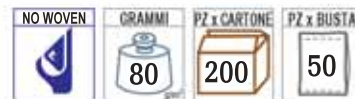

12 bordeaux





934 PORTACALICE

Laccio cm. 90

Misura largh. cm. 18 x alt. cm. 22,5

Materiale TNT

Peso 80 gr./m²

Stampa serigrafica



area stampa cm. 11x12



02 nero

12 bordeaux



12 bordeaux

01 bianco

958 BAVAGLIO IN TNT

Misura cm. 35x46

Materiale TNT

Stampa serigrafica



area stampa cm. 25x15



02 nero



04 verde



05 blu navy



927 SET GUANTO + PRESINA

Misura presina cm. 17,5x17,5

Misura guanto cm. 16,5x26

Materiale cotone naturale

Stampa serigrafica

QUADRICOMIA a richiesta



area stampa cm. 6,5x7



area stampa cm. 10x10



01 bianco



03 rosso



22 naturale

950 GREMBIULE

2 tasche

Misura largh. cm. 55 x alt. cm. 75

Materiale cotone naturale

Peso 135 gr./m²

Stampa serigrafica

QUADRICOMIA a richiesta



area stampa cm. 18x10





963 GREMBIULE REGOLABILE CON FIBBIA IN METALLO

Laccetto regolabile con fibbia in metallo

Bordato con tasca centrale

Misura largh. cm 60 x alt. 92

Stampa serigrafica

QUADRICOMIA a richiesta



FIBBIA
IN
METALLO



area stampa cm. 18x10

POLYCOTTON

GRAMMI

PZ x CARTONE

PZ x BUSTA



100%

180

120

12



12 bordeaux

01 bianco



949 GREMBIULE

Tasca centrale aperta
Misura largh. cm 60 x alt. 90
Stampa serigrafica

QUADRICOMIA a richiesta



area stampa cm. 18x10

01 bianco

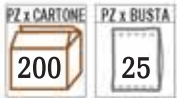
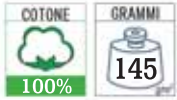

952 GREMBIULE

Tasca centrale aperta
Misura largh. cm 60 x alt. 90
Stampa serigrafica

QUADRICOMIA a richiesta



area stampa cm. 18x10

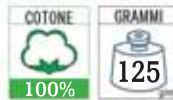

21 verde mela



02 nero

14 azzurro



967 GREMBIULE DA BAR

Grembiule corto con tre tasche aperte

Misura largh. cm 48,5 x alt. cm 34

Taglia unica

Stampa serigrafica

QUADRICOMIA a richiesta



area stampa cm. 8x16,5

COTONE	GRAMMI	PZ x CARTONE	PZ x BUSTA
100%	180	200	50

02 nero



03 rosso

05 blu navy



960 GREMBIULE DA BAR

Grembiule corto con tre tasche aperte

Misura largh. cm 70x alt. cm 42

Taglia unica

Stampa serigrafica

QUADRICOMIA a richiesta



area stampa cm. 12x15

COTONE	GRAMMI	PZ x CARTONE	PZ x BUSTA
100%	180	120	10

12 bordeaux





932 PORTAPANE

Chiusura con laccetto

Misura cm. 56x22

Materiale cotone naturale 100 gr/mq

Stampa serigrafica

QUADRICOMIA a richiesta

area stampa cm. 25x12

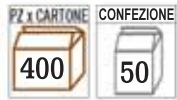

22 naturale

729 TAGLIERE CON COLTELLO APRIBOTTIGLIE

Tagliere antiscivolo rigido

Coltello - Apribottiglia con guaina

In astuccio

Misura tagliere cm. 18,5x28

Materiale ABS e metallo

Stampa serigrafica

QUADRICOMIA a richiesta



area stampa cm. 16x1,5



27 fuxia



864 BORSA FRIGO ALTA CAPACITA'
(12 LATTINE)

Tasca esterna
Tasca laterale con retina
Tracolla regolabile
Interno in pvc argentato
Misura cm. 23 x 15 x 26
Materiale poliester 70 D
Stampa serigrafica

QUADRICOMIA a richiesta



area stampa cm. 12x10



10 blu royal



04 verde



07 arancio



07 arancio

865 BORSA TERMICA PORTAVIVANDE

Vassoio in plastica 3 scomparti con coperchio
Forchetta e coltello in plastica
Interno in pvc argentato
Misura cm. 23x15x26
Materiale poliester 70 D
Stampa serigrafica

QUADRICOMIA a richiesta



area stampa cm. 12x3,5



NON SOLO SHOPPER

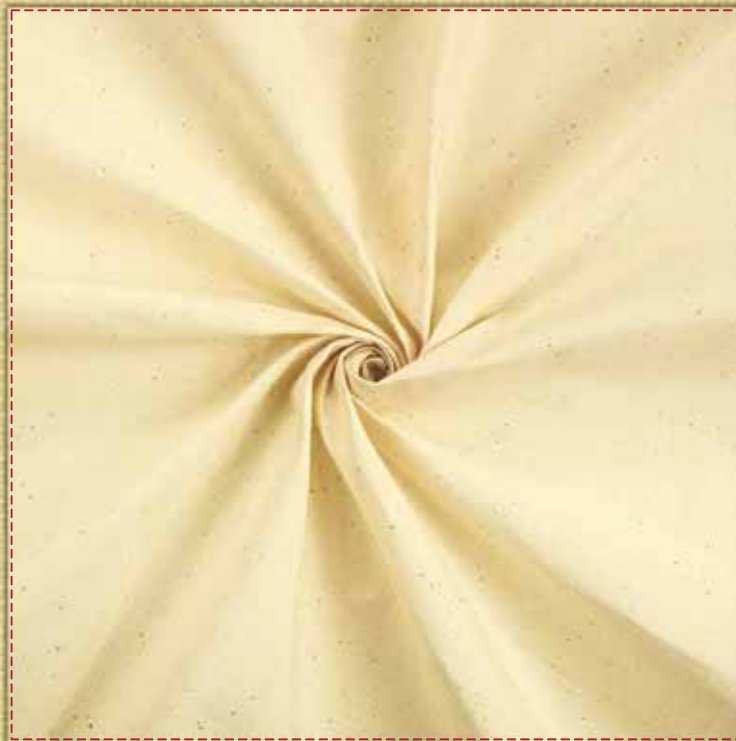

COTONE - TNT - CARTA

**SHOPPER - ZAINETTI - TRACOLLE
RISTORAZIONE**



TAKE AWAY

IN CARTA ECOLOGICA RICICLATA

521 AVANA

cm. 32x22x32
Manica piatta



area stampa
cm.26x26*

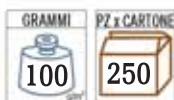

550 BIANCO

cm. 32x22x32
Manica piatta



519 AVANA

cm. 27x17x29
Manica ritorta



area stampa
cm.22x21*

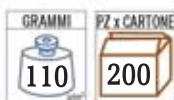

546 BIANCO

cm. 27x17x29
Manica ritorta



* Le misure di stampa sono indicative



TAKE AWAY

624 TAKE AWAY IN TNT CON SOFFIETTO

Manici cm. 40
Materiale tnt cucito gr. 80
Stampa serigrafica



area stampa cm. 20x23

NO WOVEN	GRAMMI	PZ x CARTONE	PZ x BUSTA
	80	200	50

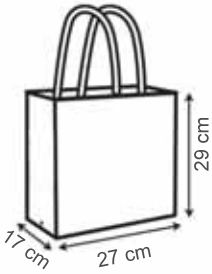

12 bordeaux



01 bianco

625 TAKE AWAY IN TNT CON SOFFIETTO

Manici cm. 40
Materiale tnt cucito gr. 80
Stampa serigrafica



area stampa cm. 25x28

NO WOVEN	GRAMMI	PZ x CARTONE	PZ x BUSTA
	80	200	50

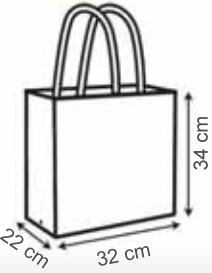

01 bianco



12 bordeaux



BORSE MANICI RITORTI IN CARTA KRAFT RICICLATO



615 AVANA

cm. 45x16x49



area stampa
cm. 25x20*

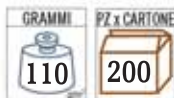

614 AVANA

cm. 32x17x45



area stampa
cm. 20x20*



613 AVANA

cm. 26x13x41



area stampa
cm. 18x24*



612 AVANA

cm. 22x12x29



area stampa
cm. 15x18*



611 AVANA

cm. 19x8x23



area stampa
cm. 12x16*



STAMPA
in
QUADRICROMIA

BORSE MANICI RITORTI IN CARTA KRAFT BIANCA



619 BIANCO

cm. 45x16x49



area stampa
cm. 25x20*

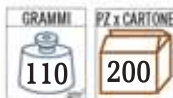

618 BIANCO

cm. 32x17x45



area stampa
cm. 20x20*



617 BIANCO

cm. 26x13x41



area stampa
cm. 18x24*



616 BIANCO

cm. 22x12x29



area stampa
cm. 15x18*



621 BIANCO

cm. 19x8x23



area stampa
cm. 12x16*



STAMPA
in
QUADRICROMIA

842 SHOPPER PLASTIFICATA

Manici in cordoncino

Rinforzo in cartoncino alla base

Materiale carta plastificata gr. 157

Stampa serigrafica

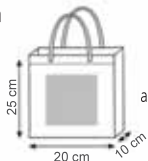

area stampa cm. 14x16



01 bianco
Plastificazione
opaca



02 nero
Plastificazione
lucida



03 rosso
Plastificazione
lucida



13 marrone
Plastificazione
opaca



845 SHOPPER PLASTIFICATA

Manici in cordoncino

Rinforzo in cartoncino alla base

Materiale carta plastificata gr. 220

Stampa serigrafica

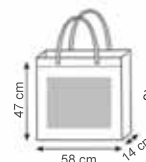

area stampa cm. 48x30



01 bianco
Plastificazione
opaca



02 nero
Plastificazione
lucida



03 rosso
Plastificazione
lucida



13 marrone
Plastificazione
opaca

843 SHOPPER PLASTIFICATA

Manici in cordoncino

Rinforzo in cartoncino alla base

Materiale carta plastificata gr. 200

Stampa serigrafica

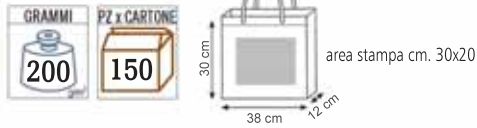

01 bianco
Plastificazione
opaca



02 nero
Plastificazione
lucida



03 rosso
Plastificazione
lucida



13 marrone
Plastificazione
opaca



844 SHOPPER PLASTIFICATA

Manici in cordoncino

Rinforzo in cartoncino alla base

Materiale carta plastificata gr. 200

Stampa serigrafica

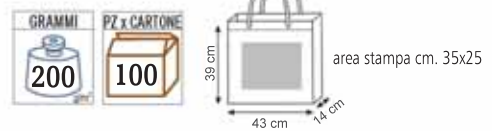

01 bianco
Plastificazione
opaca



02 nero
Plastificazione
lucida



03 rosso
Plastificazione
lucida



13 marrone
Plastificazione
opaca



894 TRACOLLA CANVAS

Pattina con chiusura a velcro

Tracolla regolabile

Misura cm 25 x 31 x 5

Materiale cotone pesante "canvas"

Stampa serigrafica

QUADRICOMIA a richiesta



area stampa cm. 15x16

COTONE 100%	GRAMMI 180
PZ x CARTONE 100	PZ x BUSTA 10





829 ZAINO IN COTONE



Misura cm 36 x 46
Materiale cotone ecrù
Stampa serigrafica

QUADRICOMIA arichiesta



area stampa cm. 21x29

COTONE	GRAMMI
100%	125

PZ x CARTONE	PZ x BUSTA
250	50





959 BORSA IN COTONE COLORATO

Manici cm. 35x2,5
Stampa serigrafica



area stampa cm. 21x29,7

COTONE 100%	GRAMMI 125	PZ x CARTONE 250	PZ x BUSTA 50
--------------------	-------------------	-------------------------	----------------------



06 giallo

07 arancio



05 blu navy

14 azzurro





954 BORSA IN COTONE COLORATO

Manici Lunghi cm. 70x2,5

Stampa serigrafica



area stampa cm. 21x29,7



01 bianco



02 nero



05 blu navy



06 giallo



21 verde mela





928 BORSA IN NATURAL COTTON

Manici Lunghi

Manici cm. 70x2,7

Stampa serigrafica

QUADRICOMIA a richiesta



area stampa cm. 21x29



22 naturale





932 PORTAPANE

Chiusura con laccetto
Misura cm. 56x22
Materiale cotone naturale 100 gr/mq
Stampa serigrafica
QUADRICOMIA a richiesta

area stampa cm. 25x12

PZ x CARTONE	CONFEZIONE
400	50



22 naturale



950 GREMBIULE

2 tasche
Misura largh. cm. 55 x alt. cm. 75
Materiale cotone naturale
Peso 135 gr./m²
Stampa serigrafica
QUADRICOMIA a richiesta

area stampa cm. 18x10

GRAMMI	PZ x CARTONE	CONFEZIONE
135	200	50



22 naturale

961 MAXI BORSA-BORSELLINO

Chiusura con Bottone
Tasca laterale con Cerniera
Manici cm. 65

Materiale tnt cucito gr. 80
cuciture termiche

Stampa serigrafica



area stampa cm. 30x20



03 rosso



05 blu navy

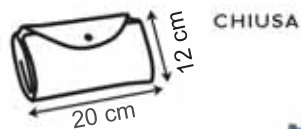
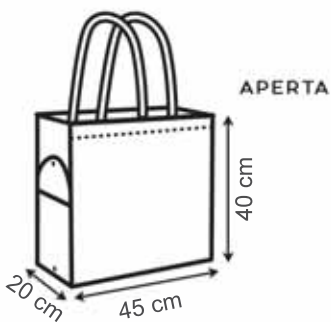

CAPACITA'
36 LITRI

Tasca laterale
con cerniera



10 blu royal

888 BORSA - BORSELLINO

Chiusura a velcro
 Tasca esterna
 Manici cm. 50
Materiale tnt cucito gr. 80
Stampa serigrafica



area stampa cm. 13x6,5



area stampa cm. 8x4

NO WOVEN	GRAMMI	PZ x CARTONE	PZ x BUSTA
	80	400	50

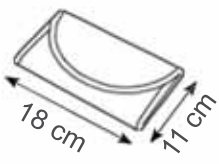
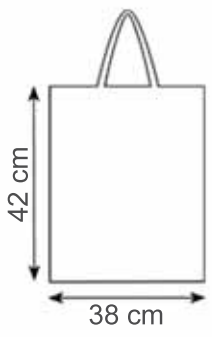

01 bianco



03 rosso



04 verde



05 blu navy



10 blu royal



889 BORSA PILOTA

Chiusura con cerniera
Tasca esterna con chiusura a velcro
Fondello rinforzato
Misura cm. 40 x 36 x 20
Materiale tnt cucito gr. 90
Stampa serigrafica



area stampa cm. 23x10

NO WOVEN	GRAMMI	PZ x CARTONE	PZ x BUSTA
	90	100	20



02 nero



05 blu navy



10 blu royal

962 BORSA DENIM CON SOFFIETTI

Manici cm. 50x3

Materiale tnt laminato denim

Cuciture termiche

Stampa serigrafica

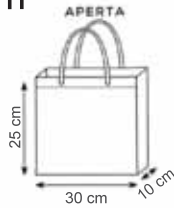

area stampa cm. 21x16



DENIM



44 denim



972 BORSA DENIM CON SOFFIETTI

Manici cm. 50x3

Materiale tnt laminato denim

Cuciture termiche

Stampa serigrafica

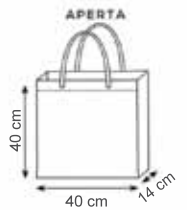

area stampa cm. 28x30



968 BORSA GLITTER CON SOFFIETTI

Manici cm. 36x2,5

Materiale laminato e glitterato

Cuciture termiche

Stampa serigrafica



area stampa cm. 10x12



CHIUSA

APERTA

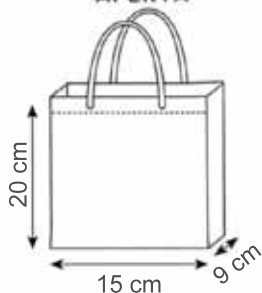

10 glitter blu royal
Manici grigi



27 glitter fuxia
Manici grigi

976 BORSA GLITTER CON SOFFIETTI

Manici cm. 40x3

Materiale laminato e glitterato

Cuciture termiche

Stampa serigrafica



area stampa cm. 15x16



CHIUSA

APERTA

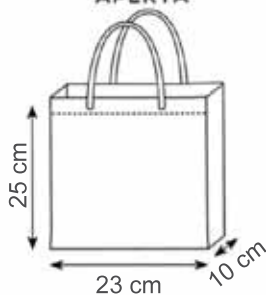

10 glitter blu royal
Manici grigi



27 glitter fuxia
Manici grigi

982 BORSA TNT LAMINATO

Manici cm. 70x3
Materiale tnt laminato opaco
 cuciture termiche
Stampa serigrafica



NO WOVEN	GRAMMI	PZ x CARTONE	PZ x BUSTA
	125	100	50

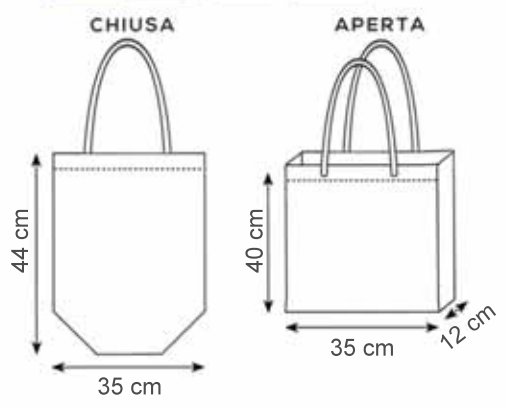

981 BORSA TNT LAMINATO

Manici cm. 50x3

Materiale tnt laminato opaco gr. 125

cuciture termiche

Stampa serigrafica



area stampa cm. 20x28



CHIUSA



APERTA

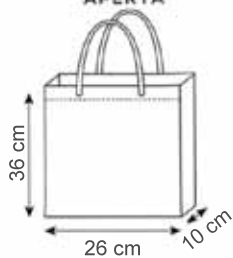

01 bianco



02 nero



07 arancio



10 blu royal



21 verde mela



05 blu navy

983 BORSA TNT LAMINATO

Manici cm. 40x2
Materiale tnt laminato opaco
 cuciture termiche
Stampa serigrafica



NO WOVEN	GRAMMI	PZ x CARTONE	PZ x BUSTA
	140	200	50

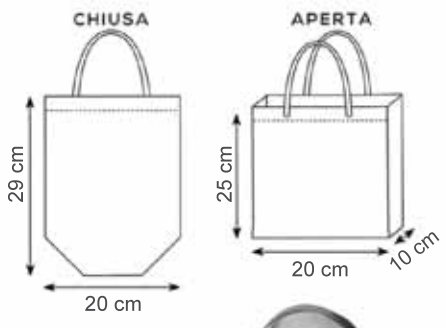

01 bianco



02 nero



03 rosso



05 blu navy



10 blu royal



951 BORSA TNT GRANDE

Manici cm. 50x2,5

Materiale tnt cuciture termiche

Stampa serigrafica



area stampa cm. 30x30

NO WOVEN	GRAMMI	PZ x CARTONE	PZ x BUSTA
	80	250	20

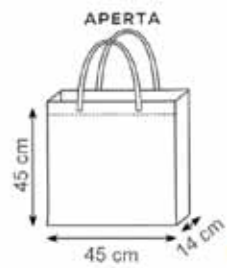

01 bianco



02 nero



03 rosso



04 verde



05 blu navy



07 arancione



10 blu royal



12 bordeaux



624 BORSA TNT CON SOFFIETTO

Manici cm. 40
Materiale tnt cucito gr. 80
Stampa serigrafica



area stampa cm. 20x23

NO WOVEN	GRAMMI	PZ x CARTONE	PZ x BUSTA
	80	200	50



12 bordeaux

01 bianco

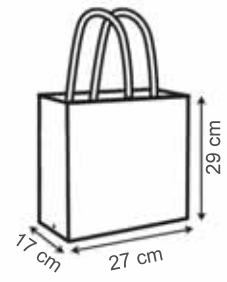

01 bianco



12 bordeaux

625 BORSA TNT CON SOFFIETTO

Manici cm. 40
Materiale tnt cucito gr. 80
Stampa serigrafica



area stampa cm. 25x28

NO WOVEN	GRAMMI	PZ x CARTONE	PZ x BUSTA
	80	200	50

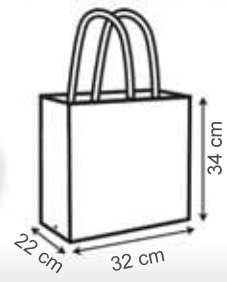



953 BORSA TNT BIANCO CON SOFFIETTI

Manici cm. 70x2,5

Materiale tnt - Cuciture termiche

Stampa serigrafica



area stampa cm. 28x28



CHIUSA

APERTA

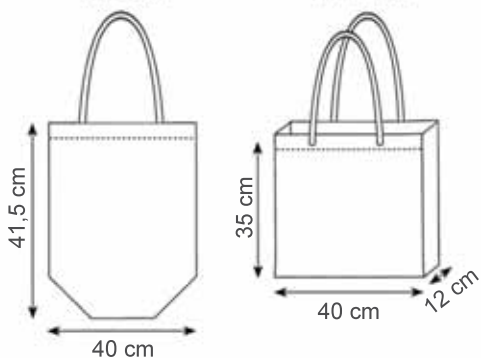

936 BORSA TNT MAXI CON SOFFIETTI

Manici Lunghi

Manici cm. 70x2,5

Materiale tnt cuciture termiche gr. 80

Stampa serigrafica



area stampa cm. 21x29,7

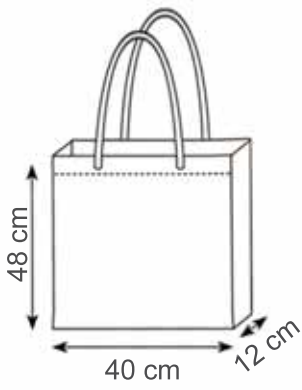
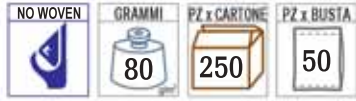

01 bianco



02 nero



03 rosso



04 verde



10 blu royal



05 blu navy

938 BORSA TNT CON SOFFIETTI

MANICI LUNGI

Manici cm. 70x2,5

Materiale tnt cuciture termiche gr.80

Stampa serigrafica



area stampa cm. 26x35



CHIUSA

APERTA

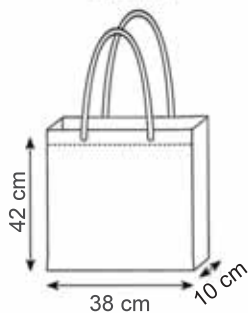

01 bianco



02 nero



03 rosso



04 verde



05 blu navy



06 giallo



10 blu royal



07 arancione



12 bordeaux



709 BORSA TNT CON SOFFIETTI

Manici cm. 45x2,5

Materiale tnt cuciture termiche gr.80

Stampa serigrafica



area stampa cm. 21x28,7

NO WOVEN	GRAMMI	PZ x CARTONE	PZ x BUSTA
	80	250	50

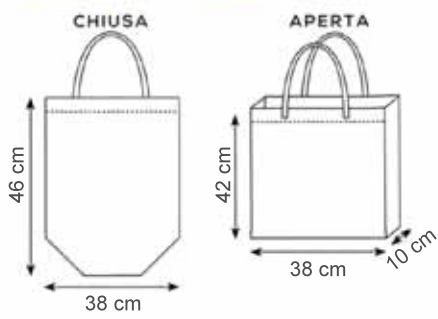

- 01 bianco
- 02 nero
- 03 rosso
- 04 verde
- 05 blu navy
- 06 giallo
- 07 arancio
- 10 blu royal



933 BORSA IN TNT COLORATO

Manici cm. 70x2

Cuciture termiche

Materiale tnt gr. 80

Stampa serigrafica



area stampa cm. 21x29,7



01 bianco

02 nero

03 rosso

04 verde

05 blu navy

06 giallo

07 arancio

10 blu royal

714 BORSA IN TNT COLORATO

Manici cm. 50x2
 Cuciture termiche
 Materiale tnt gr. 70
 Stampa serigrafica



area stampa cm. 21x29,7

NO WOVEN	GRAMMI
PZ x CARTONE	PZ x BUSTA



01 bianco



02 nero



03 rosso



05 blu navy



07 arancio



10 blu royal



12 bordeaux



14 azzurro



21 verde mela



27 fuxia



38 blu notte





977 BORSA TNT CON SOFFIETTI

Manici cm. 41x3

Materiale tnt cuciture termiche gr. 80

Stampa serigrafica



area stampa cm. 17x19

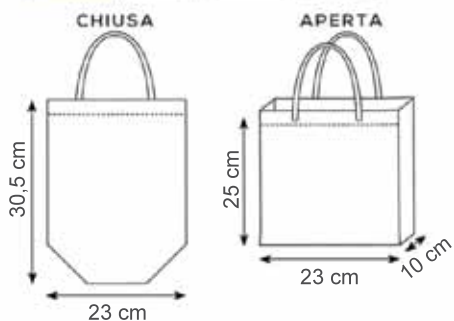

01 bianco



03 rosso



07 arancione



10 blu royal



12 bordeaux

944 PORTAPIZZE TRICOLORE

Capienza 6 Pizze
Laccetto per chiusura
Misura cm. 36x37x36
Materiale tnt gr. 80
Stampa serigrafica



area stampa cm. 28x15

NO WOVEN	GRAMMI	PZ x CARTONE	PZ x BUSTA
	80	200	50



939 BORSA T-SHIRT CON SOFFIETTI

Manici integrati

Materiale tnt gr. 60

Cuciture termiche

Stampa serigrafica

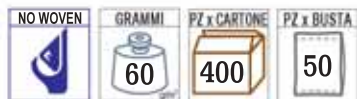

area stampa cm. 19x18

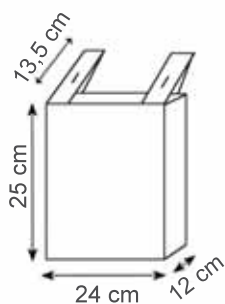

10 blu royal



01 bianco



03 rosso



06 giallo



05 blu navy

940 BORSA T-SHIRT CON SOFFIETTI

Manici integrati

Materiale tnt gr. 60

Cuciture termiche

Stampa serigrafica



area stampa cm. 21x29,7

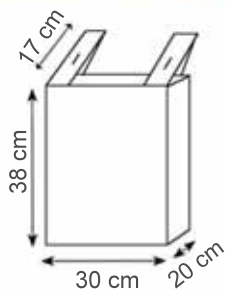



935 BORSA TNT

Manici occhiello
Materiale tnt cuciture termiche
Stampa serigrafica



area stampa cm. 22x26

NO WOVEN	GRAMMI	PZ x CARTONE	PZ x BUSTA
	 80	 300	 50

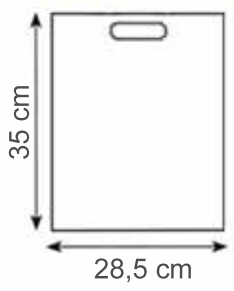

02 nero



03 rosso



10 blu royal



22 naturale

04 verde

966 BORSA "PANDA"

969 BORSA "SPIGA"

Ripiegabile in borsellino
Chiusura con bottone
Moschettone portachiavi
Manici cm. 13x6
Materiale poliestere
Stampa serigrafica



area stampa cm. 22x15

POLIESTERE	GRAMMI	PZ x CARTONE	PZ x BUSTA
 100%	 100	 192	 96

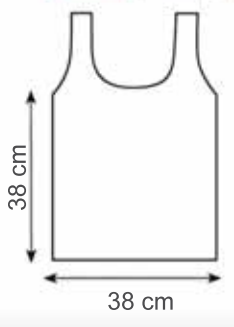

06 giallo



01 bianco

937 BORSA PER SUBLIMAZIONE

Manici lunghi cm 70x2,5

Materiale pet

Stampa sublimazione



area stampa cm. 20x28

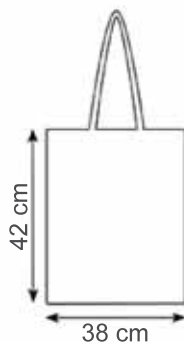

SUBLIMATICA



831 ZAINO CON RINFORZO

Laccio colorato

Angoli rinforzati in PVC

Laccetti in tinta

Occhielli in metallo

Misura cm 36 x 42

Materiale poliestere 190 T

Stampa sublimazione



02 nero



03 rosso



04 verde



05 blu navy



06 giallo



area stampa cm. 20x23



SUBLIMATICA



949 GREMBIULE

Tasca centrale aperta
Misura largh. cm 60 x alt. 90
Stampa serigrafica
QUADRICOMIA a richiesta



area stampa cm. 18x10

COTONE	GRAMMI
100%	145
PZ x CARTONE	PZ x BUSTA
200	25



01 bianco





934 PORTACALICE

Laccio cm. 90

Misura largh. cm. 18 x alt. cm. 22,5

Materiale TNT

Peso 80 gr./m²

Stampa serigrafica



area stampa cm. 11x12



02 nero

12 bordeaux



12 bordeaux

01 bianco

958 BAVAGLIO IN TNT

Misura cm. 35x46

Materiale TNT

Stampa serigrafica



area stampa cm. 25x15



05 blu navy

04 verde

02 nero

979 PORTABOTTIGLIA GLITTER

Manici cm. 34x2,5
 Misura cm. 12x36x12
 Materiale laminato e glitterato gr. 140
 Cuciture termiche
 Stampa serigrafica

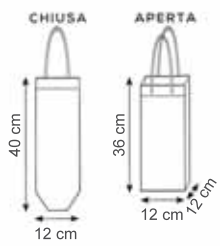

11 glitter oro

988 PORTABOTTIGLIA

Manici cm. 34x2,5
 Misura cm. 13x38x10
 Materiale tnt gr. 80
 Cuciture termiche
 Stampa serigrafica

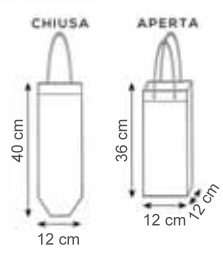
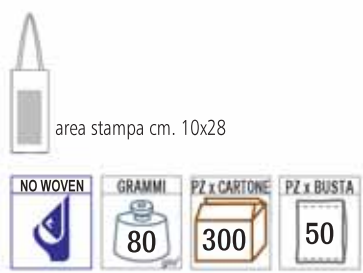

12 bordeaux

835 PORTABOTTIGLIE 2 POSTI

Con separatore interno
 Misura cm. 18x34x10
 Materiale tnt gr. 80
 Cuciture termiche
 Stampa serigrafica



12 bordeaux



TIME

OROLOGI DA MURO E DA TAVOLO
SVEGLIE • BATTERIE





763 OROLOGIO STAZIONE METEO IN BAMBÙ

In astuccio

Misura cm. 13x13x2,3

Materiale bambù e plastica

Stampa serigrafica

QUADRICOMIA a richiesta



area stampa cm. 9x2,5



Per appendere a parete



Con supporto tavolo



TEMPERATURA



UMIDITA'



OROLOGIO



SVEGLIA-ALLARM SNOOZE



CALENDARIO



ISTRUZIONI IN INGLESE ED ITALIANO



BAMBOO



783

OROLOGIO CIRCOLARE DOPPIO QUADRANTE

Doppio quadrante a scelta (bianco o nero)

Silent moviment high quality

Misura diam. cm. 28

Materiale PVC

Stampa serigrafica



area stampa cm. 8x3



**DOPPIO
QUADRANTE**



02 nero



09 silver



692 OROLOGIO ANALOGICO AL QUARZO
CON CALENDARIO AUTOMATICO A SCATTO

Funzione icona giorno/notte

Domenica in rosso

Alimentazione a batterie

In astuccio

Misura cm 43 x 63 x 12,9

Materiale abs e metallo

Stampa serigrafica



area stampa cm. 19X1,5





791

OROLOGIO ANALOGICO "STAND" QUADRANTE PERSONALIZZATO

Silent movement high quality

In astuccio

Misura Diam. cm 25 - altezza cm 146

Materiale metallo spazzolato

Stampa serigrafica

QUADRICOMIA a richiesta



area stampa cm. 8x3



09 silver



787 OROLOGIO "PIERRE CARDIN"

Silent moviment high quality

Vetro minerale

In astuccio

Misura diam cm 30

Materiale Alluminio

Stampa serigrafica

QUADRICOMIA a richiesta



area stampa diam cm. 30
altezza cm 7



788 OROLOGIO CIRCOLARE CON STAZIONE METEO

Termometro

Igrometro

Silent moviment high quality

In astuccio

Misura diam. cm 28,5

Materiale PVC metalizzato

Stampa serigrafica

QUADRICOMIA a richiesta



area stampa diam cm. 28,5
diam min cm. 21
altezza cm 2,8



02 nero



05 blu scuro



03 rosso



04 verde

LIGHTER

**PIEZO • PIETRINA • CON LUCE • POSACENERI DA TAVOLO,
TASCABILI E DA SPIAGGIA**



610 POSACENERE IN VETRO

Misura diam. cm. 10,5

Materiale vetro

Stampa serigrafica

QUADRICOMIA a richiesta



area stampa diam. cm. 8,5

PZ x CARTONE

48





606 ACCENDINO PIEZO CON LUCE

Ricaricabile

Misura cm. 2,7x8,2x1,2

Materiale plastica e metallo

Stampa serigrafica



area stampa cm. 5x1,2



02 nero



09 silver



05 blu navy



02 nero



01 bianco



05 blu navy



605 ACCENDINO TURBO

Ricaricabile

Misura cm. 7,9x2,5x1,2

Materiale plastica e metallo

Stampa serigrafica

QUADRICOMIA a richiesta



area stampa cm. 4,5x1,2

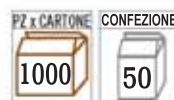



608 ACCENDINO PIEZO CANDLE

Canna in metallo
Ricaricabile
Misura cm. 12x2,5x1,2
Materiale plastica e metallo
Stampa serigrafica

QUADRICOMIA a richiesta



area stampa cm. 4,5x1,2



CANNA LUNGA IDEALE PER CUCINA E BARBECUE



01 bianco

02 nero



603 ACCENDINO PIEZO

Ricaricabile
Misura cm. 2,6x8,1x0,8
Materiale plastica e metallo
Stampa serigrafica

QUADRICOMIA a richiesta



area stampa cm. 4,5x1,2



01 bianco

02 nero

03 rosso

05 blu navy





600 ACCENDINO PROMO

A pietra

Misura cm. 2,4x8,2x1

Materiale plastica e metallo

Stampa serigrafica

QUADRICOMIA a richiesta



area stampa cm. 4,5x1,2



01 bianco

02 nero

03 rosso

04 verde

06 giallo

10 blu royal

602 ACCENDINO PROMO TRASPARENTE

A pietra

Misura cm. 2,4x8,2x1

Materiale plastica e metallo

Stampa serigrafica

QUADRICOMIA a richiesta



area stampa cm. 4,5x1,2



03 rosso

04 verde

07 arancio

10 blu royal

601 ACCENDINO APRIBOTTIGLIA

A pietra

Misura cm. 2,5x8,9x1,1

Materiale plastica e metallo

Stampa serigrafica

QUADRICOMIA a richiesta



area stampa cm. 3,5x1,2



01 bianco



02 nero



03 rosso



04 verde



06 giallo



10 blu royal





604 ACCENDINO PIEZO

Ricaricabile

Misura cm. 2,6x8x0,9

Materiale plastica e metallo

Stampa serigrafica

QUADRICOMIA a richiesta



area stampa cm. 5x1,2



02 nero



01 bianco



03 rosso



05 blu



06 giallo



728 POSACENERE TASCABILE

Chiusura con bottone

Interno silver ignifugo

Misura cm. 8x8 (chiuso)

Materiale plastica

Stampa serigrafica

QUADRICOMIA a richiesta



fronte
area stampa cm. 5,5x2



retro
area stampa cm. 5,5x4



05 blu navy



14 azzurro



21 verde mela



01 bianco





737 POSACENERE DA SPIAGGIA

Ignifugo
 Misura diam. cm 6x8,5
 Materiale abs
 Stampa serigrafica
QUADRICOMIA a richiesta



area stampa diam. cm. 4,7

PZ x CARTONE	CONFEZIONE
480	120



10 blu royal



04 verde



07 arancio



01 bianco



03 rosso



05 blu navy



06 giallo

329 PORTACHIAVI MULTIUSO

Spessore 3/10
 Misura mm 240x190 (aperto)
 Materiale PVC + cristal
 Stampa serigrafica

QUADRICOMIA a richiesta



area stampa cm. 2,8x2,8

PZ x CARTONE	CONFEZIONE
500	100

METRICA

METRI IN ABS E LEGNO

ROLLINE

FLESSIMETRO

CUTTER

MATITE FALEGNAME





802 DOPPIO METRO IN LEGNO

Professionale
 Stecca ribassata
 Qualità controllata
 Certificazione CE
Misura cm. 23,5x3,3x1,5
Materiale legno
Stampa serigrafica
QUADRICOMIA a richiesta
 area stampa cm. 18x0,5



408 MATITA FALEGNAME

Misura Lunghezza cm. 18
Materiale Legno
Stampa serigrafica
QUADRICOMIA a richiesta

area stampa cm. 10x0,6



03 rosso



803 STOP MASTER 3 MT.

Autobloccaggio
 Tasto per riavvolgimento automatico
 Clip in metallo sul retro
 Nastro acciaio 16 mm.
 High quality
 Certificazione CE
Misura cm. 6x6x3
Materiale abs e metallo
Stampa serigrafica

QUADRICOMIA a richiesta



area stampa diam. cm. 3,3

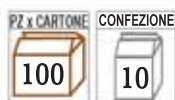

805 STOP MASTER 5 MT.

Autobloccaggio
 Tasto per riavvolgimento automatico
 Clip in metallo sul retro
 Nastro acciaio 16 mm.
 High quality
 Certificazione CE
Misura cm. 6,5x6,5x3
Materiale abs e metallo
Stampa serigrafica

QUADRICOMIA a richiesta



area stampa diam. cm. 3,5





**804 METRO MORBIDO
1,5 MT.**

Doppia misurazione cm. / pollici
Riavvolgimento automatico

Misura diam. cm. 5

Materiale plastica

Stampa serigrafica

 area stampa diam. cm. 3,5

PZ x CARTONE	CONFEZIONE
500	50



03 rosso



05 blu navy



04 verde



retro

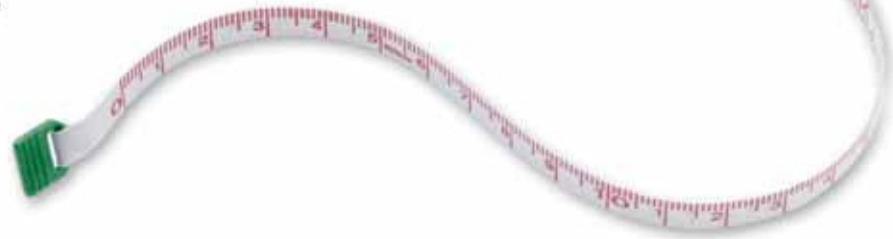

**811 ROLLINA METRICA
10 MT.**

Rotellina e particolari in metallo

Nastro in abs morbido

High quality

Certificazione CE

In astuccio

Misura diam. cm. 9,5

Materiale abs e metallo

Stampa serigrafica

area stampa  cm. 4,5 cm. 9,2

PZ x CARTONE	CONFEZIONE
60	10



651 CUTTER CON LAMA PROGRESSIVA

Fermo di sicurezza

Misura cm. 15,3x3x1,5

Materiale plastica e metallo

Stampa serigrafica

QUADRICOMIA a richiesta



area stampa cm. 7x0,8



05 blu navy



301 MINI CUTTER CON LAMA PROGRESSIVA

Fermo di sicurezza

Catenina portachivi

Misura cm. 7,5x2x0,7

Materiale PVC + cristal

Stampa serigrafica

QUADRICOMIA a richiesta



area stampa cm. 5x0,8



01 bianco



02 nero



04 verde



RAIN

**OMBRELLI
IMPERMEABILI**



992 OMBRELLO "SOFT COLOR"

Stecche in fiber glass

Canna in metallo mm. 10

Manico in Ewa bicolore

Misura diam. cm. 105

Materiale poliestere 190T

Stampa serigrafica

QUADRICOMIA a richiesta



area stampa cm. 18x10



03 rosso



06 giallo



07 arancione



08 grigio



10 blu royal



Stecche in fiber glass





991 OMBRELLO "FLAG"

Stecche in fiber glass

Canna in metallo verniciato nero mm. 10

Manico curvo in plastica

Misura diam. cm. 105

Materiale poliestere 190T

Stampa serigrafica

QUADRICOMIA a richiesta



area stampa cm. 18x10



31 tricolore



03 rosso



04 verde



994 OMBRELLO AUTOMATICO "MAXI GOLF POWER"

Stecche in fiber glass
Canna in alluminio mm. 14
Manico soft touch effetto pelle
Misura diam. cm. 125
Materiale nylon taffetà 190D
Stampa serigrafica

QUADRICOMIA a richiesta



area stampa cm. 18x10





970 OMBRELLO MAXI GOLF
"COLORBRELLA"

Automatico
Stecche in fiber glass colorate
Canna in metallo verniciato nero mm. 14
Misura diam. cm. 125
Materiale nylon taffetà 190D
Stampa serigrafica

QUADRICOMIA arichiasta



area stampa cm. 18x10



03 rosso



14 azzurro



21 verde mela

Manico ergonomico in soft touch





990 OMBRELLO AUTOMATICO "MAXI GOLF EXTRA"

Stecche in fiber glass
Canna in metallo nero mm. 12
Manico in Rubber
Misura diam. cm. 125
Materiale poliestere 190T
Stampa serigrafica

QUADRICOMIA a richiesta



area stampa cm. 18x10



03 rosso

04 verde

05 blu navy

10 blu royal

14 azzurro



Stecche in fiber glass



Manico nero in rubber



996 OMBRELLO AUTOMATICO "GOLF COLOR"

Stecche in fiber glass
 Canna in metallo mm. 10
 Manico in Ewa bicolore
 Misura diam. cm. 105
 Materiale poliestere 190T
 Stampa serigrafica
QUADRICOMIA a richiesta



area stampa cm. 18x10

PZ x CARTONE	CONFEZIONE
48	12



01 bianco

03 rosso

04 verde

05 blu navy

10 blu royal



Stecche in fiber glass





993 OMBRELLO AUTOMATICO "PIEGHEVOLE COLOR"

Rib in metallo temperato piegato e rinforzato

Guaina in nylon abbinato

Manico in Ewa con laccetto

Misura diam. cm. 92 - chiuso cm. 40x5

Materiale poliestere 190T

Stampa serigrafica

QUADRICOMIA a richiesta



area stampa cm. 18x10

area stampa cm. 8x1,2



PZ x CARTONE

CONFEZIONE

60

12



04 verde

06 giallo

989 OMBRELLO AUTOMATICO "STYLE"

Rib in metallo temperato piegato e rinforzato

Fusto in metallo verniciato mm. 12

Manico in pvc e rubber

Misura diam. cm. 105

Materiale poliestere 190T

Stampa serigrafica

QUADRICOMIA a richiesta



area stampa cm. 16x10



PZ x CARTONE

CONFEZIONE

36

12



09 silver



998 OMBRELLO MINI 3 SEZIONE - AUTOMATICO - PIEGHEVOLE DA BORSA

Rib in metallo temperato piegato e rinforzato

Fusto in metallo verniciato nero

Guaina in nylon abbinato

Manico in PVC, particolari silver plastificato

Misura diam. cm. 92 - chiuso cm. 29,5x5,5

Materiale poliestere 190T

Stampa serigrafica

QUADRICOMIA a richiesta



area stampa cm. 15x10



04 verde



08 grigio



03 rosso



10 blu royal





995 OMBRELLO AUTOMATICO "WOOD CON BORDINO"

Manico, fusto e puntale in legno
Rib. in metallo temperato, piegato e rinforzato

Misura diam. cm. 105

Materiale poliestere 190T

Stampa serigrafica

QUADRICOMIA a richiesta



area stampa cm. 18x10



14 azzurro



04 verde



07 arancio



13 marrone



BORDO CUCITO



955 BOX IMPERMEABILE

Impermeabile con cappuccio

Materiale PVC

Misura unica

Astuccio rigido con moschettone

Misura diam. 5 x altezza cm. 5

Materiale plastica

Stampa serigrafica

QUADRICOMIA a richiesta

area stampa diam. cm. 4



07 arancio



10 blu royal



01 bianco



930

GIACCA PIOGGIA CON CAPPUCCIO

Richiudibile a marsupio con cintura elastica
 Polsini con elastico
 Chiusura con cerniera
 Tasche con cerniera
 Cordoncino stringivita
Stampa serigrafica



area stampa cm. 9



area stampa cm. 28

S	M	L	XL	XXL
---	---	---	----	-----



03 rosso



05 blu navy



06 giallo



10 blu royal





956 GIACCONE ANTIPIOGGIA
CON CAPPUCCIO

In pochette PVC
Chiusura con bottoni
Taglia unica
Stampa serigrafica



area stampa cm. 9



area stampa cm. 28



03 rosso



974 GIACCONE ANTIPIOGGIA
CON CAPPUCCIO

In pochette PVC
Chiusura con bottoni
Stampa serigrafica

M | L



area stampa cm. 9



area stampa cm. 28

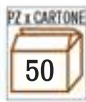

05 blu navy

06 giallo





957 ZAINO JACKET

Giubbino - Zaino impermeabile
Cappuccio a scomparsa
Zaino doppio scomparto con cerniera
Tracolla regolabile
Stampa serigrafica



area stampa cm. 9



area stampa cm. 14x16

L

XL

XXL

POLYCOTTON



PZ x CARTONE



PZ x BUSTA



05 blu navy



10 blu royal

CLOTHING

**CAPS
T-SHIRT
POLO
FELPE**





900 T-SHIRT PREMIER WHITE

Alta vestibilità uomo-donna
 collo con rinforzo h = cm 1,5
 tessuto tubolare irrestingibile stabilizzato
Confezione: pronto stampa buste a parte (include)



PREMIER



S	M	L	XL	XXL	3 XL
---	---	---	----	-----	------

COTONE 100%	GRAMMI 145	PZ x CARTONE 120	PZ x BUSTA 10
----------------	---------------	---------------------	------------------

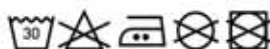

01 bianco
3XL

02 nero
3XL

04 verde

05 blu navy
3XL

MIER



901 T-SHIRT PREMIER COLOR

Alta vestibilità uomo-donna
collo con rinforzo h = cm 1,5
tessuto tubolare irrestringibile stabilizzato
Confezione: pronto stampa buste a parte (include)

Stampa serigrafica

S	M	L	XL	XXL	3 XL
---	---	---	----	-----	------

Taglia 3XL: disponibile nei colori 02-05-10-32



COTONE 100%	GRAMMI 145	PZ x CARTONE 120	PZ x BUSTA 10
----------------	---------------	---------------------	------------------



Fettuccia tergisudore colorata



06 giallo

07 arancio

10 blu royal
3XL

32 grigio scuro
3XL



903 T-SHIRT ADULTI COLOR

Collo con rinforzo h= mm15
Tessuto tubolare irrestingibile stabilizzato
Stampa serigrafica



902 T-SHIRT ADULTI WHITE

Collo con rinforzo h= mm15
Tessuto tubolare irrestingibile stabilizzato
Stampa serigrafica

S M L XL XXL 3XL

COTONE	GRAMMI	PZ x CARTONE	PZ x BUSTA
100%	145	60	10





902

T-SHIRT ADULTI WHITE

FULL COLOR

903

T-SHIRT ADULTI COLOR



01 bianco 3XL

02 nero 3XL

03 rosso

04 verde



05 blu navy 3XL

06 giallo

08 grigio melange

10 blu royal



14 azzurro

19 rosa

29 lilla

33 turchese



1231 T-SHIRT ADULTI WHITE

Collo con rinforzo h= mm15

Tessuto tubolare irrestingibile stabilizzato

Stampa serigrafica

S M L XL XXL

COTONE	GRAMMI	PZ x CARTONE	PZ x BUSTA
100%	160	60	10

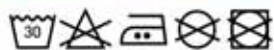



1232 T-SHIRT ADULTI COLOR

Collo con rinforzo h= mm15
Tessuto tubolare irrestrictibile stabilizzato
Stampa serigrafica

S M L XL XXL

COTONE	GRAMMI	PZ x CARTONE	PZ x BUSTA
100%	160	60	10



07
arancione

14
azzurro

04 verde

36
grigio
melange
scuro

12
bordeaux
3XL / 4XL

27
fuxia

06
giallo

02
nero

10
blu royal
3XL / 4XL

39
verde
bottiglia



908 T-SHIRT KID COLOR



03 rosso



04 verde



06 giallo



07 arancio



10 blu royal



Collo con rinforzo
Doppia impuntura spalla, collo, manica e bordino
Tessuto tubolare irrestringibile stabilizzato

Stampa serigrafica

BAMBINO

4 | 6 | 8 | 10 | 12

POLIESTERE 100%	COTONE 100%	GRAMMI 145	PZ x CARTONE 60	PZ x BUSTA 10
------------------------	--------------------	-------------------	------------------------	----------------------



907 T-SHIRT KID WHITE



01 bianco



1202 T-SHIRT ADULTO BIANCA

Tessuto **tecnico traspirante**
Girocollo manica raglan
Doppia cucitura collo
Stampa serigrafica



01 bianco

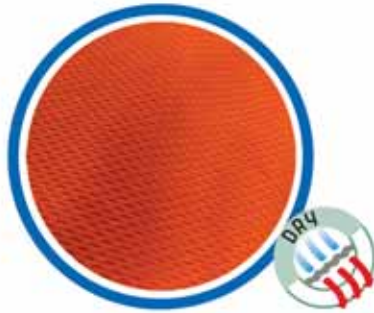

1203 T-SHIRT ADULTO COLORATA

Tessuto **tecnico traspirante**
Girocollo manica raglan
Doppia cucitura collo
Stampa serigrafica

ADULTO S M L XL XXL

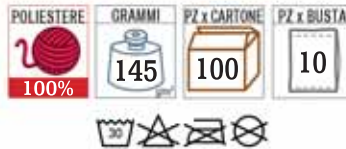

1204 T-SHIRT ADULTO COLORATA

Tessuto **tecnico traspirante**
Girocollo manica raglan
Doppia cucitura collo
Stampa serigrafica



37 celeste

21 verde mela

03 rosso

27 fuxia



F19 rosa fluo

F07 arancio fluo



36 grigio scuro

14 azzurro

10 blu royal

02 nero



F42 giallo fluo

F04 verde fluo



1241 T-SHIRT SUBLIMATICA
ADULTO BIANCA

Collo ryb con lycra
Rinforzo da spalla a spalla
Doppia cucitura al collo, maniche e al fondo
Stampa sublimatica

ADULTO					
S	M	L	XL	XXL	3XL

POLIESTERE 100%	GRAMMI 160	PZ x CARTONE 100	PZ x BUSTA 10
--------------------	---------------	---------------------	------------------



1242 T-SHIRT SUBLIMATICA
BIMBO BIANCA

Collo ryb con lycra
Rinforzo da spalla a spalla
Doppia cucitura al collo, maniche e al fondo
Stampa sublimatica

BAMBINO		
4/5	6/8	10/12



01 bianco



1226 T-SHIRT MANICHE LUNGHE COLORATO

Cotone **ring spun.**
Doppia cucitura sul collo, maniche e vite
Interno garzato
Stampa serigrafica

02 nero



03 rosso

08 grigio melange



10 blu royal

32 grigio scuro



38 blu notte

3XL

S M L XL XXL 3XL

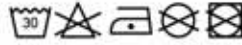

1225 T-SHIRT MANICHE LUNGHE BIANCO

Cotone **ring spun.**
Doppia cucitura sul collo, maniche e vite
Interno garzato
Stampa serigrafica



01 bianco 3XL





1208 T-SHIRT LADY COLORATO

Cotone **ring spun.**
Doppia cucitura sul collo, maniche e vita
Stampa serigrafica

DONNA					
XS	S	M	L	XL	XXL

COTONE 100%	GRAMMI 160	PZ x CARTONE 100	PZ x BUSTA 10
--------------------	-------------------	-------------------------	----------------------



1207 T-SHIRT LADY BIANCO

Cotone **ring spun.**
Doppia cucitura sul collo, maniche e vita
Stampa serigrafica



01 bianco



02 nero



03 rosso



07 arancione



14 azzurro



19 rosa



21 verde mela





1214 CANOTTA DONNA SAGOMATA
COLORATA

Tessuto elasticizzato
Spalla larga
Stampa serigrafica



02 nero



03 rosso



07 arancione



14 azzurro



19 rosa



21 verde mela



27 fuxia



37 celeste

1213 CANOTTA DONNA SAGOMATA
BIANCA

Tessuto elasticizzato
Spalla larga
Stampa serigrafica



01 bianco

XS S M L XL XXL

ELASTICIZZATO 5%	COTONE 95%	GRAMMI 190
---------------------	---------------	---------------

PZ x CARTONE 100	PZ x BUSTA 10
---------------------	------------------



**1248****POLO ADULTO
PATROL**

Cotone pettinato ring spun - Tessuto piquet 100%
 Collo e bordo manica tricot
 Doppie cuciture spalle e giromanica
 2 bottoni in tinta
 Taschino in tinta pronto da cucire
Stampa serigrafica

ADULTO						
XS	S	M	L	XL	XXL	3XL

**1255****POLO BAMBINO
PATROL**

Cotone pettinato ring spun - Tessuto piquet
 Collo e bordo manica tricot
 Doppie cuciture spalle e giromanica
 2 bottoni in tinta
 Taschino in tinta pronto da cucire
Stampa serigrafica

BAMBINO					
2	3	4	5	6-8	10-12



01 bianco



02 nero



03 verde



05 blu navy



06 giallo



08 grigio chiaro



10 blu royal



12 bordeaux



32 grigio scuro



36 grigio melange



37 celeste



1234 POLO DONNA

Polo donna manica corta
 Chiusura due bottoni tono in tinta
 Taschino incluso pronto da cucire
 Leggermente attillata
 Costina 1x1 su collo e maniche
 Spacchetti laterali rinforzati
Stampa serigrafica

S M L XL XXL

COTONE	GRAMMI	PZ x CARTONE	PZ x BUSTA
	220	50	5
100%			



01 bianco

02 nero

03 rosso



37 celeste

38 blu notte

910 POLO START 2 BOTTONI

Chiusura due bottoni tono su tono
 Spacchetti laterali rinforzati
 Cotone Piquet
Stampa serigrafica

S M L XL XXL

COTONE	GRAMMI	PZ x CARTONE	PZ x BUSTA
	200	50	5
100%			



01 bianco



03 rosso



08 grigio



07 arancio





1210 POLO UOMO TRICOLORE

Cotone piquè
 Chiusura tre bottoni tono su tono
 Costina 1x1 su collo e maniche
Stampa serigrafica

XS S M L XL XXL 3XL

COTONE 100%	GRAMMI 190	PZ x CARTONE 30	PZ x BUSTA 5
----------------	---------------	--------------------	-----------------



01 bianco

02 nero

03 rosso

05 blu navy



10 blu royal



01 bianco

1205 POLO UOMO TRICOLORE SUBLIMATICA BIANCA

Poliestere
 Chiusura due bottoni
 Costina 1x1 su collo e maniche
Stampa sublimatica

S M L XL XXL

POLIESTERE	GRAMMI 170	PZ x CARTONE 50	PZ x BUSTA 5
------------	---------------	--------------------	-----------------



1215 FELPA CON CAPPuccio

2 tasche comunicanti
Cordoncino cappuccio in tinta
Elastico stringivita
Polsini elasticizzati
Stampa serigrafica

S M L XL XXL



01 bianco



02 nero



03 rosso



04 verde



08 grigio



10 blu royal



32 grigio scuro



38 blu notte



1228 FELPA ZIP INTERA E CAPPuccio

Tasche a marsupio
 Cordino cappuccio in tinta
 Elastico stringivita
 Polsini elasticizzati
 Stampa serigrafica

S M L XL XXL



02 nero



01 bianco



03 rosso



36 grigio scuro

3XL



38 blu notte

3XL





1256 FELPA ZIP INTERA E CAPPUCCIO

Tessuto felpa con interno garzato 280 gr/m
 Cappuccio in tessuto con cordoncino regolabile
 Chiusura con cerniera lunga e tasca frontale
 Manica lunga raglan, polsini e fondo in costina
 Stampa serigrafica

S M L XL XXL

POLIESTERE 100%	GRAMMI 280	PZ x CARTONE 20	PZ x BUSTA 1
--------------------	---------------	--------------------	-----------------



01 bianco



02 nero



03 rosso



10 blu royal



36 grigio scuro

3XL



38 blu notte

3XL



1238 FELPA GIROCOLLO

Polsini e girovita elasticizzati
Interno garzato
Stampa serigrafica

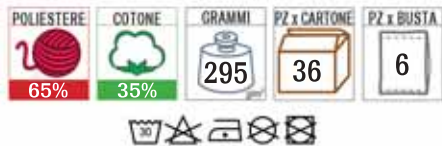

ADULTO						
S	M	L	XL	XXL	3XL	4XL

1237 FELPA GIROCOLLO BAMBINO

Polsini e girovita elasticizzati
Interno garzato
Stampa serigrafica

BAMBINO		
4/5	6/8	10/12



45 verde kelly
BIMBO / ADULTO
3XL

21 verde mela
BIMBO / ADULTO

24 beige
ADULTO

01 bianco
BIMBO / ADULTO
3XL - 4XL





06 giallo
BIMBO / ADULTO



38 blu notte
BIMBO / ADULTO
3XL - 4XL



08 grigio melange
BIMBO / ADULTO
3XL - 4XL



55 giallo ocra
ADULTO



03 rosso
BIMBO / ADULTO
3XL - 4XL



07 arancione
BIMBO / ADULTO



36 melange scuro
BIMBO / ADULTO
3XL - 4XL



19 rosa
BIMBO / ADULTO



50 grigio azzurro
BIMBO / ADULTO



02 nero
ADULTO
3XL



12 bordeaux
ADULTO
3XL



14 azzurro
BIMBO
ADULTO



10 blu royal
BIMBO / ADULTO
3XL - 4XL



1216 FELPA CON CAPPuccio BICOLORE

Felpe cappuccio colore in contrasto
 Cordoncino di colore abbinato al colore interno del cappuccio
 Tasca a marsupio
 Fondo e polsini elasticizzati
Stampa serigrafica

S M L XL XXL

POLIESTERE 50%	COTONE 50%	GRAMMI 280	PZ x CARTONE 25	PZ x BUSTA 5
-------------------	---------------	---------------	--------------------	-----------------



01 bianco



03 rosso



912 FELPA GIROCOLLO

Polsini elasticizzati
 Elastico stringivita
Stampa serigrafica

S M L XL XXL

POLIESTERE 65%	COTONE 35%	GRAMMI 280	PZ x CARTONE 36	PZ x BUSTA 6
-------------------	---------------	---------------	--------------------	-----------------



02 nero



03 rosso



10 blu royal



30 sabbia





02 nero

913 FELPA MEZZA ZIP

Doppia cucitura al collo, polsini e girovita
Costina 1x1 con lycra su collo, polsini e girovita
Stampa serigrafica

01 bianco

03 rosso

08 grigio melange



area stampa base cm. 9/11



area stampa base cm. 25/28

S | M | L | XL | XXL

POLIESTERE 65%	COTONE 35%	GRAMMI 295	PZ x CARTONE 25	PZ x BUSTA 5
-------------------	---------------	---------------	--------------------	-----------------

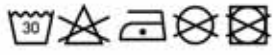

10 blu royal

30 sabbia



38 blu notte





915 CAPS SUPER TRICOLORE

- 5 pannelli
- Visiera rigida sagomata
- Occhielli ricamati
- Frontalino rinforzato
- Chiusura posteriore in velcro regolabile
- Fascia tergisudore

Stampa serigrafica

QUADRICOMIA a richiesta



area stampa frontale cm. 9x4,5



area stampa laterale base cm. 5



01 bianco



02 nero



05 blu navy



10 blu royal

BANDIERA RICAMATA



920 CAPS GOLF SANDWICH



5 pannelli
 Visiera rigida sagomata
 Occhielli ricamati
 Frontalino rinforzato
 Chiusura posteriore in velcro regolabile
 fascia tergisudore
Misura unica
Stampa serigrafica

QUADRICOMIA a richiesta



area stampa frontale mm. 90x45



area stampa laterale base mm. 50



100%



PZ x CARTONE
200



PZ x BUSTA
50



01 bianco



02 nero



05 blu navy



10 blu royal



03 rosso



919 CAPS SUPER GOLF



- 5 pannelli
- Colori reattivi
- Occhielli ricamati
- Frontalino rinforzato
- Chiusura posteriore in velcro regolabile
- Fascia tergisudore
- Frontalino rinforzato
- Visiera rigida sagomata
- Misura unica
- Stampa serigrafica

QUADRICOMIA a richiesta



area stampa frontale mm. 90x45



area stampa laterale base mm. 50



01 bianco



02 nero



03 rosso



04 verde



05 blu navy



06 giallo



07 arancione



10 blu royal



12 bordeaux



14 azzurro



21 verde mela



914 CAPS GOLF



- 5 pannelli
- Visiera rigida sagomata
- Occhielli ricamati
- Frontalino rinforzato
- Chiusura posteriore in velcro regolabile
- Fascia tergisudore
- Frontalino rinforzato
- Visiera rigida sagomata
- Misura unica
- Stampa serigrafica

QUADRICOMIA a richiesta



area stampa frontale mm. 90x45



area stampa laterale base mm. 50



VISIERA PRECURVATA



01 bianco



02 nero



03 rosso



04 verde



05 blu navy



06 giallo



10 blu royal



14 azzurro



07 arancione



925 CAPS GOLF CATARIFRANGENTE



5 pannelli
 Bordino e regolatore in materiale catarifrangente
 Visiera rigida sagomata con inserto
 Occhielli ricamati
 Frontalino rinforzato
 Chiusura posteriore in velcro regolabile
 Fascia tergisudore
Stampa unica
Stampa serigrafica

QUADRICOMIA a richiesta



area stampa frontale mm. 90x45



area stampa laterale base mm. 50



06 giallo



02 nero



05 blu navy



07 arancione



Catarifrangente



Catarifrangente



918 CAPS GOLF BAMBINO



- 5 pannelli
- Visiera rigida sagomata
- Occhielli ricamati
- Frontalino rinforzato
- Chiusura posteriore in velcro regolabile
- fascia tergisudore
- Misura unica
- Stampa serigrafica

QUADRICOMIA a richiesta



area stampa frontale mm. 90x45



area stampa laterale base mm. 50



04 verde

VISIERA PRECURVATA



01 bianco



03 rosso



06 giallo



10 blu royal



917 CAPS MIRAMARE

Bicolore
Fascia tergisudore
Misura unica
Stampa serigrafica



05 blu navy

03 rosso



31 tricolore



area stampa base cm. 14x4,5



926 CAPS EMERGENCY

In pochette
apertura automatica a scatto
Stampa serigrafica

QUADRICOMIA a richiesta



area stampa base mm. 90x40



area stampa base mm. 65x35



01 bianco

07 arancio



04 verde



1264 CUFFIA DONNA CON RETINA SMOOTHY

Tessuto a rete traspirabile 90% poliestere e 10% cotone 150gr/m2
Parte superiore ampia con banda elastica per i capelli
Stampa serigrafica

QUADRICOMIA a richiesta



area stampa cm. 9x4

POLIESTERE 90%	COTONE 10%	GRAMMI 150	PZ x CARTONE 200	PZ x BUSTA 10
-------------------	---------------	---------------	---------------------	------------------



01 bianco



02 nero



929 CUFFIA CON RETINA

Stampa serigrafica

QUADRICOMIA a richiesta



area stampa cm. 9,5x4,5

COTONE 100%	GRAMMI 180	PZ x CARTONE 200	PZ x BUSTA 50
----------------	---------------	---------------------	------------------



01 bianco



943 FAZZOLETTO TRIANGOLARE

Tessuto taffetà
Con orlo cucito
Stampa serigrafica

ADULTO

70 x 70 x 100 cm

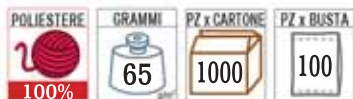

01 bianco



02 nero



03 rosso



04 verde

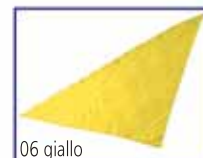

06 giallo



07 arancio



10 blu royal



14 azzurro



19 rosa

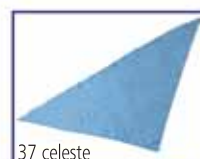

37 celeste



38 blu notte





942 SCALDACOLLO - COPRICAPO - FASCIA PER CAPELLI

Tubolare - multiuso
Misura cm 25x47
Stampa serigrafica



area stampa cm. 20x6



01 bianco



02 nero



05 blu navy



07 arancio



10 blu royal



21 verde mela





924 CAPS ELASTICIZZATO

Doppio Strato
Stampa serigrafica



area stampa cm. 12x4

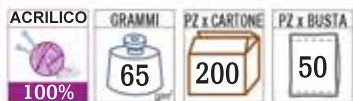

02 nero



05 blu navy



10 blu royal



32 grigio scuro



923 CAPS ELASTICIZZATO

Targhetta per la personalizzazione
Stampa serigrafica



area stampa cm. 4,5x2



02 nero



05 blu navy



08 grigio



10 blu royal



32 grigio scuro





964 SCALDACOLLO

Copricapo - Fascia per capelli
Laccetto con fermo

Misura b = cm 29
h = cm 26
(chiuso)

Stampa serigrafica



area stampa base cm. 14x5



01 bianco



02 nero



03 rosso



05 navy



10 blu royal



08 grigio



32 Grigio scuro



921 ZUCCOTTO POLAR

Pile anti peeling
6 pannelli
MISURA unica
Stampa serigrafica



area stampa cm. 6x2,5



02 nero



03 rosso



32 grigio scuro



38 blu notte



1271 COPERTA KODIAK

Tessuto pile

Misura cm. 158x130

Stampa serigrafica

QUADRICOMIA a richiesta



area stampa cm. 40x20



01 bianco



02 nero



03 rosso



04 verde



05 blu navy



07 arancio



08 grigio



10 blu royal



13 marrone



21 verde mela



24 beige



27 fuxia



02 nero

1272 GUAINA PER COPERTA COMFY

Con manico

Chiusura con velcro

Targhetta per personalizzazione

Misura cm. 40x20

Materiale Tessuto e poliestere

Stampa serigrafica

QUADRICOMIA a richiesta



area stampa cm. 8x4

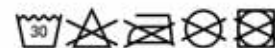
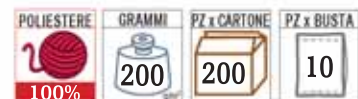

WORKWEAR TEMPO LIBERO E SPORT





916 GILET IMBOTTITO

Elastici antivento nel giromanica
 Cerniera antivento a scomparsa
 Multitasche e portacellulare
 3 tasche con pattina
 2 tasche con cerniera
 Tasca interna
Stampa serigrafica



area stampa cm. 9



area stampa cm. 28



02 nero



03 rosso



05 blu navy

M	L	XL
---	---	----

ESTERNO



INTERNO





945 GILET IMBOTTITO TRAPUNTATO

2 tasche in vita
 1 tasca in petto + 2 tasche interne
 Giromanica con elastico interno
 Cappuccio nel collo
 Interno collo e tasca in pile
Stampa serigrafica



area stampa cm. 9



area stampa cm. 28



01 bianco



02 nero



10 blu royal

S	M	L	XL	XXL
---	---	---	----	-----





922 GIUBBINO VIGILANTES

Antipioggia imbottita
Bande catarifrangenti
4 tasche con pattine
1 tasca con zip
Stampa serigrafica



area stampa cm. 9



area stampa cm. 28

ESTERNO



INTERNO



cappuccio
a scomparsa

maniche staccabili
con cerniera

portapass in pvc
trasparente

spacchetti laterali
con cerniera

cerniera
antivento



975 GILET FLUORESCENTE DI SICUREZZA

Fasce catarifrangenti
Chiusura in velcro
Taglie unica
Stampa serigrafica



area stampa cm. 9



area stampa cm. 28



Conforme a tutte le normative Europee
di abbigliamento ad alta visibilità
EN ISO 20471:2013
Attrezzatura di protezione individuale

06 giallo



07 arancione





947 GIACCA VIGILANTES

Antipioggia imbottita
 Bande catarifrangenti
 Spacchetti laterali
 3 tasche con pattina
 2 tasche con cerniera
 1 tasca interna
Stampa serigrafica



area stampa cm. 9



area stampa cm. 28

XL

XXL

ESTERNO



INTERNO



portapass
in pvc
trasparente

cappuccio
a scomparsa

maniche staccabili
con cerniera

cerniera
antivento



05 blu navy





1219 GILET MULTITASCHE SAFARI

Interno spalla foderato con retina

9 tasche davanti

2 tasche dietro

Stampa serigrafica



area stampa cm. 9



area stampa cm. 28

XS | S | M | L | XL | XXL | 3XL

POLIESTERE 65%	COTONE 35%	GRAMMI 200	PZ x CARTONE 40	PZ x BUSTA 5
-------------------	---------------	---------------	--------------------	-----------------

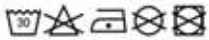

03 rosso



32 grigio scuro



02 nero



24 beige



23 verde militare

3XL



05 blu navy

3XL





971 GILET MAXWORK

2 tasche in vita
 Chiusura con cerniera
 Unisex
 Stampa serigrafica



area stampa cm. 9



area stampa cm. 28

S	M	L	XL	XXL
---	---	---	----	-----



03 rosso



05 blu navy



21 verde mela



02 nero



10 blu royal



1221 GIACCA ALTA VISIBILITA' ANETO

Giacca in pile ad alta visibilità.
 Realizzato in micropile polare molto grosso con esterno anti piega e interno trapuntato spazzolato
 Due nastri retroriflettenti cuciti su maniche, busto e schiena.
 Capo certificato come DPI categoria 13688 e 20471, classe 1.
 Colletto alto, cerniera centrale con abbottonatura interna
 Maniche raglan con vivo riflettente e fascia in vita con coulisse elastica regolabile.
 Due tasche oblique sulla fascia e una tasca verticale sul petto a sinistra, con cerniera nascosta sotto l'abbottonatura
Stampa serigrafica

POLIESTERE  65%	COTONE  35%	GRAMMI  295	PZ x CARTONE  36	PZ x BUSTA  6
				



96 blu scuro
giallo fluo



92 blu scuro
arancione fluo



32 grigio scuro



1209 GIACCA PARKA ALTA VISIBILITÀ

Tessuto esterno impermeabile
 Bande catarifrangenti cucite
 Zip con doppio cursore
 Imbottitura interna
 Collo in pile
 Cappuccio con cordoncino (riposto all'interno del collo)
 Manica con polsino interno (migliore ergonomia)
 2 tasche esterne
 1 tasca interna
Stampa serigrafica



S M L XL XXL 3XL

ESTERNO			INTERNO			PZ x CARTONE	PZ x BUSTA
POLIESTERE	PU	GRAMMI	POLIESTERE	GRAMMI	10	1	
90%	10%	180	100%	200			



ABBINABILE CON IL PANTALONE 1206



F06 giallo fluo

03 rosso

F07 arancio fluo

96 blu scuro
giallo fluo

92 blu scuro
arancione fluo

21 verde mela



04 verde

12 bordeaux

39 verde bottiglia

10 blu royal

32 grigio scuro

02 nero



1211 GIACCA PILE AIRPORT

Tessuto pile antipilling di 300 gr/m²
 Bande catarifrangenti cucite
 2 tasche con zip
 Zip totale
 Certificato alla norma EN ISO 20471:2013 / A1:2016(1/2)
 Stampa serigrafica

S M L XL XXL 3XL



**ABBINABILE
 CON IL
 PANTALONE
 1206**



F06 giallo fluo

03 rosso

F07 arancio fluo

96 blu scuro
giallo fluo

92 blu scuro
arancione fluo

21 verde mela



04 verde

12 bordeaux

39 verde bottiglia

10 blu royal

32 grigio scuro

02 nero

Indumenti che contengono più di un colore devono essere lavati a freddo, con più attenzione, utilizzando un detersivo adatto. Asciugare immediatamente non lasciare in ammollo.



1206 PANTALONI ALTA VISIBILITÀ

Bande catarifrangenti cucite
2 tasche esterne
1 tasca interna
Stampa serigrafica



S M L XL XXL 3XL

CERTIFIED
EN 20471

MONOCOLORE

BICOLORE

POLIESTERE

POLIESTERE

COTONE

GRAMMI

PZ x CARTONE

PZ x BUSTA



100%

65%

35%

210

20

1



12 bordeaux



39 verde bottiglia



10 blu royal



92 blu scuro/arancione fluo



02 nero



04 verde



21 verde mela



32 grigio scuro



F07 arancione fluo



03 rosso



F06 giallo fluo



96 blu notte/giallo fluo



1218 SMANICATO WORK

Impermeabile - imbottito
 Doppia banda catarifrangente
 Colletto rivestito in polar
 2 tasche esterne
 1 tasca interna
 Stampa serigrafica

**ABBINABILE
 CON IL
 PANTALONE
 1206**



S	M	L	XL	XXL	3XL
ESTERNO			INTERNO		
POLIESTERE	PU	GRAMMI	POLIESTERE	GRAMMI	PZ x CARTONE
90%	10%	180	200	10	1



04 verde

02 nero

92
blu notte
arancione fluo

96
blu notte
giallo fluo

39 verde bottiglia

12 bordeaux



21 verde mela

32 grigio scuro

10 blu royal

F07 arancio fluo

03 rosso

F06 giallo fluo

Indumenti che contengono più di un colore devono essere lavati a freddo, con più attenzione, utilizzando un detersivo adatto. Asciugare immediatamente non lasciare in ammollo.



1245 FELPA WORK ROAD

Tessuto felpa interno garzata 300gr/m²

Bande catarifrangenti cucite

Alta visibilità

Collo alto zip corta

Polsini e fondo in costina

Stampa serigrafica

S M L XL XXL 3XL

COTONE	GRAMMI	PZ x CARTONE	CONFEZIONE
100%	300	20	1



**ABBINABILE
CON IL
PANTALONE 1206**



96 blu notte
giallo fluo



F07 arancio fluo



F06 giallo fluo

Indumenti che contengono più di un colore devono essere lavati a freddo, con più attenzione, utilizzando un detergente adatto. Asciugare immediatamente non lasciare in ammollo.



1217 POLO WORK ALTA VISIBILITÀ

Bande catarifrangenti cucite
Collo a Polo
Chiusura 2 bottoni
Stampa serigrafica

S	M	L
XL	XXL	3XL

POLIESTERE 100%	GRAMMI 170	PZ x CARTONE 30	PZ x BUSTA 1
------------------------	-------------------	------------------------	---------------------



**ABBINABILE
CON IL
PANTALONE
1206**



F06 giallo fluo

03 rosso

F07 arancione fluo

96 blu scuro
giallo fluo

32 grigio scuro

21 verde mela



04 verde

12 bordeaux

39 verde bottiglia

10 blu royal

92 blu scuro
arancione fluo

02 nero

Indumenti che contengono più di un colore devono essere lavati a freddo, con più attenzione, utilizzando un detersivo adatto. Asciugare immediatamente non lasciare in ammollo.



1212 T-SHIRT THUNDER

T-shirt regular fit con maniche corte, design bicolore e tasca sul petto. Realizzata in tessuto di punto liscio 100% cotone ring spun, morbido e confortevole. Nastro interno da spalla a spalla che ne rinforza la struttura e ne riduce la deformazione. Tasca rinforzata per tenere tutto a portata di mano ed evidenziare la marcatura.

Stampa serigrafica

S M L XL XXL 3XL

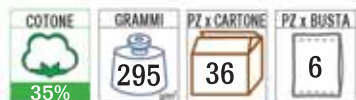

58 blu navy verde mela



59 blu navy beige



67 grigio scuro giallo



79 nero grigio scuro



66 grigio scuro blu royal



65 grigio scuro arancione



64 grigio scuro rosso



96 blu navy giallo



81 nero arancione



62 blu navy blu royal



61 blu navy verde



63 blu navy grigio scuro



60 blu navy rosso



1236 FELPA THUNDER

Tessuto felpa interno garzato
 Collo alto zip corta
 Carrè con tipping e bande laterali in contrasto
 Interno collo in contrasto
 Polsini e fondo in costina
 Doppia cucitura spalle, giromanica, polsi e al fondo
Stampa serigrafica

S M L XL XXL 3XL

POLIESTERE 65%	COTONE 35%	GRAMMI 310	PZ x CARTONE 40	PZ x BUSTA 5
-------------------	---------------	---------------	--------------------	-----------------



ABBINABILE CON IL PANTALONE 1224

Indumenti che contengono più di un colore devono essere lavati a freddo, con più attenzione, utilizzando un detersivo adatto. Asciugare immediatamente non lasciare in ammollo.



1235 SMANICATO THUNDER

Taschino lato sinistro con zip facile da ricamare o stampare
 Collo alto con zip regolatore vita sui fianchi
 1 taschino interno
 2 scomparti porta penna
 1 taschino sul petto porta cellulare
 Retro vasta area per personalizzare
 Dietro arrotondato e più lungo
 Zip interna per facilitare la personalizzazione
 Frangivento sul giromanica
Stampa serigrafica

**ABBINABILE
 CON IL
 PANTALONE
 1224**



S M L XL XXL 3XL



58 blu navy/verde mela



59 blu navy/beige



67 grigio scuro/giallo



79 nero/grigio scuro



66 grigio scuro/blu royal



65 grigio scuro/arancione



64 grigio scuro/rosso



96 blu navy/giallo



81 nero/arancione



62 blu navy/blu royal



61 blu navy/verde



63 blu navy/grigio scuro



60 blu navy/rosso



1223 POLO THUNDER

Tessuto piquet
 Collo e bordo manica tricot
 Doppie cuciture spalle e giro maniche
 2 bottoni in tinta
 Spacchetti laterali
Stampa serigrafica

S M L XL XXL 3XL



**ABBINABILE
 CON IL
 PANTALONE 1224**



58 blu navy/ verde mela

59 blu navy/beige

67 grigio scuro/giallo



79 nero/grigio scuro

66 grigio scuro/blu royal

65 grigio scuro/arancione

64 grigio scuro/rosso

96 blu navy/giallo



81 nero/arancione

62 blu navy/blu royal

61 blu navy/verde

63 blu navy/grigio scuro

60 blu navy/rosso

Indumenti che contengono più di un colore devono essere lavati a freddo, con più attenzione, utilizzando un detersivo adatto. Asciugare immediatamente non lasciare in ammollo.



1224 PANTALONI WORK THUNDER

Tessuto in twill
 elastico nella parte posteriore
 2 tasche sui fianchi
 2 tasche laterali chiusura con patella
 2 tasche posteriori con patella con chiusura a velcro
 cuciture rinforzate
Stampa serigrafica

S M L XL XXL 3XL

POLIESTERE 65%	COTONE 35%	GRAMMI 240	PZ x CARTONE 20	PZ x BUSTA 1
-------------------	---------------	---------------	--------------------	-----------------



67
grigio scuro
giallo



81
nero
arancione



61
blu notte
verde



63
blu notte
grigio scuro



60
blu notte
rosso



62
blu notte
blu royal



58
blu navy
verde mèla



79
nero
grigio scuro



65
grigio scuro
arancione



64
grigio scuro
rosso



66
grigio scuro
blu royal



96
blu notte
giallo



59
blu navy
beige



1267 FARFALLINA

Fiocco fisso cucito
Chiusura a gancio regolabile
Misura cm 6,5x10x51

MICROFIBRA 100%	GRAMMI 250	PZ x CARTONE 100	PZ x BUSTA 1
------------------------	-------------------	-------------------------	---------------------



12 bordeaux



01 bianco



02 nero



1268 CRAVATTA MONACO

Accessorio classico in tessuto siffice in colori lisci
Misura cm. 156x8,2
Materiale 100% poliestere
Stampa serigrafica

QUADRICOMIA a richiesta



area stampa cm. 4x1

MICROFIBRA 100%	GRAMMI 250	PZ x CARTONE 200	PZ x BUSTA 1
------------------------	-------------------	-------------------------	---------------------



01 bianco



02 nero



03 rosso



05 blu navy



07 arancio



10 blu royal



12 bordeaux



1262 GIUBBOTTO ADULTO SAPONI

Tessuto tecnico SOFTSHELL
 3 tasche con zip
 Zip totale
 Polsino regolabile con chiusura velcro
 Stampa serigrafica

POLIESTERE 85%	PU 10%	 5%
GRAMMI 350	PZ x CARTONE 10	PZ x BUSTA 1

1263 GIUBBOTTO BAMBINO SAPONI

Tessuto tecnico SOFTSHELL
 3 tasche con zip
 Zip totale
 Polsino regolabile con chiusura velcro
 Stampa serigrafica

**ABBINABILE
 CON IL
 PANTALONE
 1251**

ADULTO				
S	M	L	XL	XXL

BAMBINO			
3	4/5	6/8	10/12



10 blu royal
BIMBO/ADULTO

32 grigio scuro
BIMBO/ADULTO

07 arancione
BIMBO/ADULTO

03 rosso
BIMBO/ADULTO

21 verde mela
BIMBO/ADULTO



1252 SMANICATO
ADULTO TUNDRA

TESSUTO TECNICO SOFTSHELL

2 tasche con zip

Zip lunga

Stampa serigrafica

S M L XL XXL 3XL



1253 SMANICATO
BAMBINO TUNDRA

TESSUTO TECNICO SOFTSHELL

2 tasche con zip

Zip lunga

Stampa serigrafica

3 4/5 6/8 10/12



01 bianco
BIMBO / ADULTO

02 nero
BIMBO / ADULTO

03 rosso
BIMBO / ADULTO

F06 giallo fluo
BIMBO / ADULTO

**ABBINABILE
CON IL
PANTALONE 1251**



07 arancione
BIMBO / ADULTO

10 blu royal
BIMBO / ADULTO

14 azzurro
ADULTO

21 verde mela
BIMBO / ADULTO

POLYCOTTON 85%	PU 10%	ELASTICIZZATO 5%
GRAMMI 350	PZ x CARTONE 20	PZ x BUSTA 1



23 verde militare
BIMBO / ADULTO

27 fuxia
ADULTO

32 grigio scuro
ADULTO

38 blu notte
BIMBO / ADULTO



1258

GIACCA COURT PER DIVISA RAPPRESENTANZA

Tessuto acetato dual-flock 250 gr/m²

Interno garzato

2 tasche con zip

Fronte zip totale

Stampa serigrafica

ADULTO

S M L XL XXL 3XL

BAMBINO

3 4/5 6/8 10/12

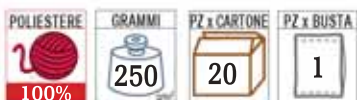

01 bianco

02 nero

03 rosso

04 verde

07 arancio

10 blu royal

12 bordeaux



14 azzurro

21 verde mela

24 beige

32 grigio scuro

38 blu notte

39 verde bottiglia

42 giallo limone



1259 PANTALONE COURT PER DIVISA RAPPRESENTANZA

Tessuto acetato dual-flock 250 gr/m²
 Interno garzato
 Elastico in vita
 Cordoncino in vita
 2 tasche in vita



ADULTO					
S	M	L	XL	XXL	3XL
BAMBINO					
3	4/5	6/8	10/12		

POLIESTERE 100%	GRAMMI 250	PZ x CARTONE 20	PZ x BUSTA 1
-------------------------------	--------------------------	-------------------------------	----------------------------



01 bianco



02 nero



03 rosso



04 verde



07 arancio



10 blu royal



12 bordeaux



14 azzurro



21 verde mela



24 beige



32 grigio scuro



blu notte



39 verde bottiglia



42 giallo limone



1240 GIACCA WORK WINTERFELL

Tessuto esterno in twill
 Tessuto interno in pile anti-pilling
 Tasca sul petto con zip
 2 tasche laterali con zip
 Zip totale
 Polsino con costina elasticizzata
 Stampa serigrafica

**ABBINABILE
 CON IL
 PANTALONE
 1201**



S M L XL XXL 3XL

ESTERNO			INTERNO			PZ x CARTONE	PZ x BUSTA
POLIESTERE	COTONE	GRAMMI	PILE ANTIPILLING	GRAMMI			
65%	35%	210	100%	200	20	1	



**INTERNO
 IN PILE**



38 blu notte



01 bianco



02 nero



10 blu royal



36 grigio scuro



1201 PANTALONE WINTERFELL

5 tasche
Elastico in vita
Doppio strato
Tessuto esterno poliestere / cotone
Tessuto interno pile anti-pilling
Stampa serigrafica

S	M	L
XL	XXL	3XL

**ABBINABILE
CON LA
GIACCA
1240**



**INTERNO
IN PILE**

INTERNO

PILE ANTIPILLING
100%

GRAMMI
200

ESTERNO

POLIESTERE 65%
COTONE 35%

GRAMMI
210

PZ x CARTONE
20

PZ x BIUSTA
1





1239 GIACCA WORK GALEN

Tessuto twill 210 gr/m
 Tasca con zip sul petto
 Zip totale
 Polsini in costina elasticizzata
 Stampa serigrafica

S M L XL XXL 3XL

POLIESTERE	COTONE	GRAMMI	PZ x CARTONE	CONFEZIONE
65%	35%	210	20	1



01 bianco

02 nero



03 rosso

04 verde

10 blu royal

12 bordeaux



32 grigio scuro

38 blu notte



**ABBINABILE
 CON IL
 PANTALONE 1260**



1260 PANTALONE MULTITASCHE CASTER

5 tasche

Elastico in vita

Stampa serigrafica

Tessuto twill misto cotone

S M L XL XXL 3XL 4XL

POLIESTERE 65%	COTONE 35%	GRAMMI 210	PZ x CARTONE 10	PZ x BUSTA 1
-----------------------	-------------------	-------------------	------------------------	---------------------



10 blu royal



03 rosso



38 blu notte



46 coloniale



24 beige



05 blu navy



04 verde



01 bianco



08 grigio



12 bordeaux



32 grigio scuro



02 nero



1251 PANTALONE RUGO

TESSUTO TECNICO SOFTSHELL

6 tasche con zip

2 laterali

2 posteriori

2 a vita

Vita con elastico posteriore

Chiusura con zip e bottoni

Stampa serigrafica

S M L XL XXL 3XL

POLIAMMIDE	ELASTICIZZATO	GRAMMI	PZ x CARTONE	PZ x BUSTA
65%	5%	350	20	1



02 nero



32 grigio scuro



01 bianco



38 blu notte



1244 PANTALONE TERMICO NEBRASKA

Tessuto twill
 Chiusura con cerniera e bottoni
 Vita con elastico
 sei tasche: due tasche anteriori,
 due tasche posteriori
 e due tasche laterali

Stampa serigrafica

S M L XL XXL 3XL

POLIESTERE	COTONE	GRAMMI	PZ x CARTONE	CONFEZIONE
65%	35%	300	20	1



02 nero



01 bianco



38 blu notte



32 grigio scuro



1220 PANTALONI WORK DARKO

2 tasche sui fianchi
 2 tasche laterali con soffietto
 1 tasca dietro
 Vita con elastico nella parte posteriore
 Ginocchiere con accesso
 Chiusura con zip e bottone
Stampa serigrafica

S M L XL XXL 3XL



**FONDOSCHIENA
 NERO**



Indumenti che contengono più di un colore devono essere lavati a freddo, con più attenzione, utilizzando un detergente adatto. Asciugare immediatamente non lasciare in ammollo.



1200 BERMUDA MULTITASCHE

6 tasche
passanti + elastico sul retro
cuciture rinforzate
Stampa serigrafica

S M L XL XXL 3XL

POLIESTERE 65%	COTONE 35%	GRAMMI 210	PZ x CARTONE 20	PZ x BUSTA 1
-------------------	---------------	---------------	--------------------	-----------------



04 verde



02 nero



24 beige



01 bianco



39 verde bottiglia



38 blu notte



32 grigio scuro



10 blu royal



1250 CAMICIA DONNA

Tessuto popeline
 Taschino lato sinistro
 Manica lunga
 taglio aderente sagomato
 Bottoni in tinta
 Stampa serigrafica

XS	S	M	L	XL	XXL
40	42	44	46	48	50

POLIESTERE 65%	COTONE 35%	GRAMMI 120	PZ x CARTONE 25	PZ x BUSTA 1
------------------------------	--------------------------	--------------------------	-------------------------------	----------------------------



14 azzurro



03 rosso



01 bianco



10 blu royal



38 blu notte



02 nero



39 verde bottiglia



19 rosa



1249 CAMICIA UOMO

Tessuto popeline
 Taschino lato sinistro
 Manica lunga
 cuciture con rinforzo su maniche e fianchi
 Bottoni in tinta
Stampa serigrafica

42 44 46 48 50 52 54



14 azzurro

35 avorio

03 rosso

04 verde

01 bianco

10 blu royal



38 blu notte

24 beige

02 nero

39 verde bottiglia

12 bordeaux

32 grigio scuro



1266 CAMICE DONNA COLORE BIANCO

Taschino lato cuore
2 tasche davanti
polsino chiusura con bottoni
Stampa serigrafica

XS S M L XL XXL

POLIESTERE 65%	COTONE 35%	GRAMMI 190	PZ x CARTONE 10	PZ x BUSTA 1
-------------------	---------------	---------------	--------------------	-----------------



01 bianco



38 blu notte

10 blu royal

1265 CAMICE UNISEX CON BOTTONI

Taschino lato cuore
2 tasche davanti
polsino chiusura con bottoni
Stampa serigrafica

S M L XL XXL 3XL

POLIESTERE 65%	COTONE 35%	GRAMMI 190	PZ x CARTONE 10	PZ x BUSTA 1
-------------------	---------------	---------------	--------------------	-----------------





02 nero



10 blu royal



32 grigio scuro



01 bianco



38 blu notte

1257 TUTA DA LAVORO

Maniche raglan con polsini elastici
2 tasche laterali + 1 tasca lato cuore
Stampa serigrafica

S M L XL XXL 3XL

POLIESTERE 65%	COTONE 35%	GRAMMI 210	PZ x CARTONE 10	PZ x BUSTA 1
-------------------	---------------	---------------	--------------------	-----------------

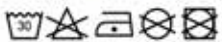



1273 CASACCA LINK

Casacca da lavoro con design a tinta unita in tessuto twill misto cotone/poliestere

- Scollo a V, ampio, comodo e fresco.
 - Spacchi laterali per un maggiore comfort.
 - Due tasche anteriori e una tasca applicata sul petto a sinistra
- Stampa** serigrafica



TAGLIE XS 3XL



01 bianco 02 nero 04 verde 07 arancio 14 azzurro 19 rosa



1274 PANTALONI PIXEL

Pantaloni da lavoro dal taglio dritto.

Realizzati in tessuto twill misto cotone/poliestere per garantire durata e resistenza.

- chiusura con bottone e zip nascosta sotto l'abbottonatura e fascia in vita con elastico per il comfort e una migliore vestibilità.
- tasca posteriore destra applicata per evidenziare il marchio.
- cuciture principali rinforzate per garantire durata e resistenza.
- metodi di marcatura adatti: serigrafia, ricamo, transfer, vinile, ecc.
- ideale per il settore sanitario, si abbina alle casacche link e helsinki.

Stampa serigrafica



TAGLIE XS 3XL



01 bianco 02 nero 04 verde 07 arancio 14 azzurro 19 rosa





1247 LEGGINGS DONNA WONDER

Leggings sportivi da donna, elastici e traspiranti. Realizzati in tessuto stretch-tec con elastan che facilita la mobilità. Fascia in vita con elastico che garantisce una migliore aderenza al corpo. Contiene una tasca interna sulla fascia in vita per riporre gli effetti personali. Ideale per le attività sportive sia all'interno che all'esterno.

Stampa serigrafica

XS	S	M	L	XL	XXL
POLIAMMIDE	ELASTICIZZATO	GRAMMI	PZ x CARTONE	PZ x BUSTA	
83%	17%	250	40	1	



02 nero



1246 LEGGINGS UOMO DRICEPS

Leggings sportivi da uomo lunghi, elastici e traspiranti. Realizzati in tessuto stretch-tec con elastan che facilitare la mobilità. Fascia in vita con elastico che garantisce una migliore aderenza al corpo. Contiene una tasca interna sulla fascia in vita per riporre gli effetti personali. Ideale per le attività sportive sia all'interno che all'esterno.

Stampa serigrafica

XS	S	M	L	XL	XXL
POLIAMMIDE	ELASTICIZZATO	GRAMMI	PZ x CARTONE	PZ x BUSTA	
83%	17%	250	40	1	



02 nero





967 GREMBIULE DA BAR

Grembiule corto con tre tasche aperte
Misura largh. cm 48,5 x alt. cm 34
Taglia unica
Stampa serigrafica

QUADRICOMIA a richiesta



area stampa cm. 8x16,5

COTONE 100%	GRAMMI 180	PZ x CARTONE 200	PZ x BUSTA 50
--------------------	-------------------	-------------------------	----------------------

02 nero



03 rosso



05 blu navy



960 GREMBIULE DA BAR

Grembiule corto con tre tasche aperte
Misura largh. cm 70x alt. cm 42
Taglia unica
Stampa serigrafica

QUADRICOMIA a richiesta



area stampa cm. 12x15

COTONE 100%	GRAMMI 180	PZ x CARTONE 120	PZ x BUSTA 10
--------------------	-------------------	-------------------------	----------------------

12 bordeaux





949 GREMBIULE

Tasca centrale aperta
Misura largh. cm 60 x alt. 90
Stampa serigrafica

QUADRICOMIA a richiesta



area stampa cm. 18x10

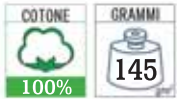

01 bianco

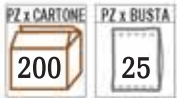

21 verde mela

952 GREMBIULE

Tasca centrale aperta
Misura largh. cm 60 x alt. 90
Stampa serigrafica

QUADRICOMIA a richiesta



area stampa cm. 18x10

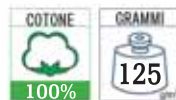

02 nero

14 azzurro



1264 CUFFIA DONNA CON RETINA SMOOTHY

Tessuto a rete traspirabile 90% poliestere e 10% cotone 150gr/m2
Parte superiore ampia con banda elastica per i capelli

Stampa serigrafica

QUADRICOMIA a richiesta

 area stampa cm. 9x4

POLIESTERE  90%	COTONE  10%	GRAMMI  150	PZ x CARTONE  200	PZ x BUSTA  10
--	--	--	--	---



01 bianco



02 nero





929 CUFFIA CON RETINA

Stampa serigrafica

QUADRICOMIA a richiesta

 area stampa cm. 9,5x4,5

COTONE  100%	GRAMMI  180	PZ x CARTONE  200	PZ x BUSTA  50
---	--	--	---



01 bianco



930

GIACCA PIOGGIA CON CAPPUCCIO

Richiudibile a marsupio
con cintura elastica
Polsini con elastico
Chiusura con cerniera
Tasche con cerniera
Cordoncino stringivita
Stampa serigrafica



area stampa cm. 9



area stampa cm. 28

S M L XL XXL



Richiudibile a marsupio



03 rosso



05 blu navy



06 giallo



10 blu royal





957 ZAINO JACKET

Giubbino - Zaino impermeabile
Cappuccio a scomparsa
Zaino doppio scomparto con cerniera
Tracolla regolabile
Stampa serigrafica



area stampa cm. 9



area stampa cm. 14x16

L

XL

XXL

POLYCOTTON

PZ x CARTONE

PZ x BUSTA



48

6



05 blu navy



10 blu royal





956 GIACCONE ANTIPIOGGIA CON CAPPuccio

In pochette PVC
Chiusura con bottoni
Taglia unica
Stampa serigrafica



area stampa cm. 9



area stampa cm. 28



03 rosso



974 GIACCONE ANTIPIOGGIA CON CAPPuccio

In pochette PVC
Chiusura con bottoni
Stampa serigrafica



area stampa cm. 9



area stampa cm. 28



05 blu navy



06 giallo

LEGENDA COLORI

COD.	COLORI	COD.	COLORI	COD.	COLORI
0	 ASSORTITI (SECONDO DISPONIBILITÀ MAGAZZINO)	21	 VERDE MELA	43	 VERDE ACIDO
01	 BIANCO	22	 NATURALE	44	 DENIM
02	 NERO	23	 VERDE MILITARE	45	 VERDE KELLY
03	 ROSSO	24	 BEIGE	46	 COLONIALE
04	 VERDE	25	 TORTORA	47	 RAME
05	 BLU NAVY	26	 SALMONE	48	 MULTICOLOR
06	 GIALLO	27	 FUXIA	49	 CANNA DI FUCILE
07	 ARANCIONE	29	 LILLA	50	 GRIGIO AZZURRO
08	 GRIGIO CHIARO	30	 SABBIA	55	 GIALLO OCRA
09	 ARGENTO	31	 TRICOLORE	F04	 VERDE FLUO
10	 BLU ROYAL	32	 GRIGIO SCURO	F06	 GIALLO FLUO
11	 ORO	33	 TURCHESE	F07	 ARANCIO FLUO
12	 BORDEAUX	34	 SENAPE	F19	 ROSA FLUO
13	 MARRONE	35	 AVORIO		
14	 AZZURRO	36	 GRIGIO MELANGE SCURO		
15	 CUOIO	37	 CELESTE		
16	 ROSSO INGLESE	38	 BLU NOTTE		
17	 TESTA DI MORO	39	 VERDE BOTTIGLIA		
18	 TRASPARENTE	40	 LIME		
19	 ROSA	41	 MATTONE		
20	 VIOLA	42	 GIALLO LIMONE		

I SUDDETTI COLORI SONO INDICATIVI; DIFFERENZE DI TONALITÀ NON POSSONO RAPPRESENTARE MOTIVI DI CONTESTAZIONE. I COLORI PANTONI DI STAMPA SONO FEDELI SOLO PER LA STAMPA LITOGRAFICA.

